

UNIMIG

RazorWeld

MIG/TIG/STICK 250



OPERATING MANUAL

KUMJRRW250MIG

Please read and understand this instruction manual carefully before the installation and operation of this equipment.

© Welding Guns Of Australia PTY LTD 2019

Thank you for your purchase of your RAZOR MIG 250 Welding Machine.

We are proud of our range of plasma cutting and welding equipment that has a proven track record of innovation, performance and reliability.

Our product range represents the latest developments in Inverter technology put together by our professional team of highly skilled engineers. The expertise gained from our long involvement with inverter technology has proven to be invaluable towards the evolution and future development of our equipment range. This experience gives us the inside knowledge on what the arc characteristics, performance and interface between man and machine should be.

Within our team are specialist welders that have a proven history of welding knowledge and expertise, giving vital input towards ensuring that our machines deliver control and performance to the utmost professional level.

We employ an expert team of professional sales, marketing and technical personnel that provide us with market trends, market feedback and customer comments and requirements. Secondly they provide a customer support service that is second to none, thus ensuring our customers have confidence that they will be well satisfied both now and in the future.

UNIMIG welders and plasma cutters are manufactured to be compliant with - AS/NZ 60974-1, guaranteeing you electrical safety and performance.

WARRANTY

- 2 Years from date of purchase.
- Welding Guns Of Australia PTY LTD Ltd warranties all goods as specified by the manufacturer of those goods.
- This Warranty does not cover freight or goods that have been interfered with.
- All goods in question must be repaired by an authorised repair agent as appointed by this company.
- Warranty does not cover abuse, misuse, accident, theft, general wear and tear.
- New product will not be supplied unless Welding Guns Of Australia PTY LTD has inspected product returned for warranty and agrees to replace product.
- Product will only be replaced if repair is not possible
- Please view full Warranty term and conditions supplied with machine or at www.unimig.com.au/warranty-registration/ or at the back of this manual.

**REGISTER YOUR MACHINE ONLINE TO RECEIVE AN
ADDITIONAL 6 MONTHS ON YOUR WARRANTY**

Visit unimig.com.au/warranty-registration/ to register your machine.

WARRANTY.....	2
SAFETY.....	4
RAZOR MIG 250 FEATURES.....	8
RAZOR MIG 250 FEATURES.....	9
MACHINE PARTS LAYOUT.....	10
MIG WITH GAS INSTALLATION.....	11
GASLESS MIG INSTALLATION.....	13
WIRE FEED ROLLER SELECTION.....	15
WIRE INSTALLATION & SET UP GUIDE.....	16
MIG TORCH LINER INSTALLATION.....	17
TORCH & WIRE FEED SET UP FOR ALUMINIUM WIRE.....	18
MIG WELDING GUIDE.....	20
SPOOL GUN SETUP.....	26
LIFT ARC DC TIG WELDING SETUP.....	28
LIFT ARC DC TIG OPERATION.....	29
DC TIG WELDING GUIDE.....	30
MMA (STICK) WELDING SET UP.....	34
MMA (STICK) WELDING GUIDE.....	35
SB24 MIG TORCH & SPARES.....	37
MIG WELDING TROUBLE SHOOTING.....	39
MIG WIRE FEED TROUBLE SHOOTING.....	40
TIG WELDING TROUBLE SHOOTING.....	41
MMA (STICK) WELDING TROUBLE SHOOTING.....	42
SPARE PARTS IDENTIFICATION.....	43
WARRANTY TERMS.....	44
NOTES.....	47

Welding and cutting equipment can be dangerous to both the operator and people in or near the surrounding working area, if the equipment is not correctly operated. Equipment must only be used under the strict and comprehensive observance of all relevant safety regulations.

Read and understand this instruction manual carefully before the installation and operation of this equipment.

Machine Operating Safety

- Do not switch the function modes while the machine is operating. Switching of the function modes during welding can damage the machine. Damage caused in this manner will not be covered under warranty.
- Disconnect the electrode-holder cable from the machine before switching on the machine, to avoid arcing should the electrode be in contact with the work piece.
- Operators should be trained and or qualified.



Electric shock: It can kill. Touching live electrical parts can cause fatal shocks or severe burns. The electrode and work circuit is electrically live whenever the output is on. The input power circuit and internal machine circuits are also live when power is on. In MIG/MAG welding, the wire, drive rollers, wire feed housing, and all metal parts touching the welding wire are electrically live. Incorrectly installed or improperly grounded equipment is dangerous.

- Connect the primary input cable according to Australian and New Zealand standards and regulations.
- Avoid all contact with live electrical parts of the welding/cutting circuit, electrodes and wires with bare hands.
- The operator must wear dry welding gloves while he/she performs the welding/cutting task.
- The operator should keep the work piece insulated from himself/herself.
- Keep cords dry, free of oil and grease, and protected from hot metal and sparks.
- Frequently inspect input power cable for wear and tear, replace the cable immediately if damaged, bare wiring is dangerous and can kill.
- Do not use damaged, under sized, or badly joined cables.
- Do not drape cables over your body.
- We recommend (RCD) safety switch is used with this equipment to detect any leakage of current to earth.



Fumes and gases are dangerous. Smoke and gas generated whilst welding or cutting can be harmful to people's health. Welding produces fumes and gases. Breathing these fumes and gases can be hazardous to your health.

Do not breathe the smoke and gas generated whilst welding or cutting, keep your head out of the fumes

- Keep the working area well ventilated, use fume extraction or ventilation to remove welding/cutting fumes and gases.
- In confined or heavy fume environments always wear an approved air-supplied respirator.
- Welding/cutting fumes and gases can displace air and lower the oxygen level causing injury or death. Be sure the breathing air is safe.
- Do not weld/cut in locations near de-greasing, cleaning, or spraying operations. The heat and rays of the arc can react with vapours to form highly toxic and irritating gases.
- Materials such as galvanized, lead, or cadmium plated steel, containing elements that can give off toxic fumes when welded/cut. Do not weld/cut these materials unless the area is very well ventilated, and or wearing an air supplied respirator.



Arc rays: harmful to people's eyes and skin. Arc rays from the welding/cutting process produce intense visible and invisible ultraviolet and infrared rays that can burn eyes and skin.

Always wear a welding helmet with correct shade of filter lens and suitable protective clothing including welding gloves whilst the welding/cutting operation is performed.

- Measures should be taken to protect people in or near the surrounding working area. Use protective screens or barriers to protect others from flash, glare and sparks; warn others not to watch the arc.



Fire hazard. Welding/cutting on closed containers, such as tanks, drums, or pipes, can cause them to explode. Flying sparks from the welding/cutting arc, hot work piece, and hot equipment can cause fires and burns. Accidental contact of electrode to metal objects can cause sparks, explosion, overheating, or fire. Check and be sure the area is safe before doing any welding/cutting.

- The welding/cutting sparks & spatter may cause fire, therefore remove any flammable materials well away from the working area. Cover flammable materials and containers with approved covers if unable to be moved from the welding/cutting area.
- Do not weld/cut on closed containers such as tanks, drums, or pipes, unless they are properly prepared according to the required Safety Standards to insure that flammable or toxic vapours and substances are totally removed, these can cause an explosion even though the vessel has been "cleaned". Vent hollow castings or containers before heating, cutting or welding. They may explode.
- Do not weld/cut where the atmosphere may contain flammable dust, gas, or liquid vapours (such as petrol)
- Have a fire extinguisher nearby and know how to use it. Be alert that welding/cutting sparks and hot materials from welding/cutting can easily go through small cracks and openings to adjacent areas. Be aware that welding/cutting on a ceiling, floor, bulkhead, or partition can cause fire on the hidden side.



Gas Cylinders. Shielding gas cylinders contain gas under high pressure. If damaged, a cylinder can explode. Because gas cylinders are normally part of the welding/cutting process, be sure to treat them carefully. CYLINDERS can explode if damaged.

- Protect gas cylinders from excessive heat, mechanical shocks, physical damage, slag, open flames, sparks, and arcs.
- Insure cylinders are held secure and upright to prevent tipping or falling over.
- Never allow the welding/cutting electrode or earth clamp to touch the gas cylinder, do not drape welding cables over the cylinder.
- Never weld/cut on a pressurised gas cylinder, it will explode and kill you.
- Open the cylinder valve slowly and turn your face away from the cylinder outlet valve and gas regulator.



Gas build up. The build up of gas can causes a toxic environment, deplete the oxygen content in the air resulting in death or injury. Many gases use in welding/cutting are invisible and odourless.

- Shut off shielding gas supply when not in use.
- Always ventilate confined spaces or use approved air-supplied respirator.



Electronic magnetic fields. MAGNETIC FIELDS can affect Implanted Medical Devices.

- Wearers of Pacemakers and other Implanted Medical Devices should keep away.
- Implanted Medical Device wearers should consult their doctor and the device manufacturer before going near any electric welding, cutting or heating operation.



Noise can damage hearing. Noise from some processes or equipment can damage hearing.

- Wear approved ear protection if noise level is high.



Hot parts. Items being welded/cut generate and hold high heat and can cause severe burns.

Do not touch hot parts with bare hands. Allow a cooling period before working on the welding/cutting gun. Use insulated welding gloves and clothing to handle hot parts and prevent burns.

CAUTION

1. Working Environment.

- i. The environment in which this welding/cutting equipment is installed must be free of grinding dust, corrosive chemicals, flammable gas or materials etc, and at no more than maximum of 80% humidity.
- ii. When using the machine outdoors protect the machine from direct sun light, rain water and snow etc; the temperature of working environment should be maintained within -10°C to +40°C.
- iii. Keep this equipment 30cm distant from the wall.
- iv. Ensure the working environment is well ventilated.

2. Safety Tips.

i. Ventilation

This equipment is small-sized, compact in structure, and of excellent performance in amperage output. The fan is used to dissipate heat generated by this equipment during the welding/cutting operation. Important: Maintain good ventilation of the louvres of this equipment. The minimum distance between this equipment and any other objects in or near the working area should be 30 cm. Good ventilation is of critical importance for the normal performance and service life of this equipment.

ii. Thermal Overload protection.

Should the machine be used to an excessive level, or in high temperature environment, poorly ventilated area or if the fan malfunctions the Thermal Overload Switch will be activated and the machine will cease to operate. Under this circumstance, leave the machine switched on to keep the built-in fan working to bring down the temperature inside the equipment. The machine will be ready for use again when the internal temperature reaches safe level.

iii. Over-Voltage Supply

Regarding the power supply voltage range of the machine, please refer to "Main parameter" table. This equipment is of automatic voltage compensation, which enables the maintaining of the voltage range within the given range. In case that the voltage of input power supply amperage exceeds the stipulated value, it is possible to cause damage to the components of this equipment. Please ensure your primary power supply is correct.

- iv. Do not come into contact with the output terminals while the machine is in operation. An electric shock may possibly occur.

MAINTENANCE

Exposure to extremely dusty, damp, or corrosive air is damaging to the welding/cutting machine. In order to prevent any possible failure or fault of this welding/cutting equipment, clean the dust at regular intervals with clean and dry compressed air of required pressure.

Please note that: lack of maintenance can result in the cancellation of the guarantee; the guarantee of this welding/cutting equipment will be void if the machine has been modified, attempt to take apart the machine or open the factory-made sealing of the machine without the consent of an authorized representative of the manufacturer.

TROUBLE SHOOTING

Caution: Only qualified technicians are authorized to undertake the repair of this welding/cutting equipment. For your safety and to avoid Electrical Shock, please observe all safety notes and precautions detailed in this manual.

ATTENTION! - CHECK FOR GAS LEAKAGE

At initial set up and at regular intervals we recommend to check for gas leakage

Recommended procedure is as follows:

1. Connect the regulator and gas hose assembly and tighten all connectors and clamps.
2. Slowly open the cylinder valve.
3. Set the flow rate on the regulator to approximately 8-10 L/min.
4. Close the cylinder valve and pay attention to the needle indicator of the contents pressure gauge on the regulator, if the needle drops away towards zero there is a gas leak. Sometimes a gas leak can be slow and to identify it will require leaving the gas pressure in the regulator and line for an extended time period. In this situation it is recommended to open the cylinder valve, set the flow rate to 8-10 L/min, close the cylinder valve and check after a minimum of 15 minutes.
5. If there is a gas loss then check all connectors and clamps for leakage by brushing or spraying with soapy water, bubbles will appear at the leakage point.
6. Tighten clamps or fittings to eliminate gas leakage.

IMPORTANT! - We strongly recommend that you check for gas leakage prior to operation of your machine. We recommend that you close the cylinder valve when the machine is not in use.

Welding Guns Of Australia PTY LTD, authorised representatives or agents of Welding Guns Of Australia PTY LTD will not be liable or responsible for the loss of any gas.

RAZOR MIG 250 FEATURES

UNIMIG

BUILT FOR WELDERS

3 YEAR
PRODUCT
WARRANTY



FEATURES

- 240V Single Phase
- MIG with Gas and Gasless function
- DC Lift Arc TIG
- STICK (MMA)
- Thermal overload protection
- IP21S rating for environmental/safety protection
- Geared Wire Drive
- VRD (Voltage Reduction Device)
- Spool Gun Ready

OVERVIEW

The RAZOR MIG 250 is a powerful multi-process welder offering MIG, TIG and STICK welding functions, whilst still being a portable machine. This makes the RAZOR MIG 250 ideal for welders needing powerful performance both in the workshop and site work. With a Spool Gun connection, and the ability to run all MIG Wire spool sizes, the RAZOR MIG 250 is a must-have for every serious welder.

MACHINE PACKAGE: KUMJRRW250MIG

- RAZOR MIG 250 Power Source
- 4m SB24 Sure Grip MIG Torch (including consumables)
- 4m Twist Lock Electrode Holder
- 300 Amp Earth Clamp & Lead
- Twin Gauge Argon Regulator
- 2m Gas Hose Complete with fittings
- Operating Manual

TECHNICAL DATA	
SKU	KUMJRRW250MIG
PRIMARY INPUT VOLTAGE	240V Single Phase
SUPPLY PLUG	Single Phase (32 AMP Recommended) or 15 AMP
RATED INPUT POWER (kVA)	11
I _{eff} (A)	28.0
I _{max} (A)	51.0
RATED OUTPUT	30A/15.5V - 250A/26.5V
NO LOAD VOLTAGE (V)	54
PROTECTION CLASS	IP21S
INSULATION CLASS	F
POWER FACTOR	0.72
MINIMUM GENERATOR (kVA)	13.0
DINSE CONNECTOR	35/50
STANDARD	AS/NZ60974-1
WELDS	Mild Steel, Stainless Steel, Cast Iron, Silicon Bronze, Aluminium, Copper
WARRANTY (Years)	3

MIG SPECIFICATIONS	
MIG WELDING CURRENT RANGE	30-250A
MIG DUTY CYCLE @ 40°C	30% @ 250A
MIG WIRE SIZE RANGE	0.6-1.2mm
MIG WIRE SPOOL SIZE	1kg / 5kg
MIG WELDING THICKNESS RANGE	2mm - 12mm
DRIVE ROLLER SIZE	30/22

TIG SPECIFICATIONS	
TIG FUNCTION TYPE	DC Lift Arc
TIG WELDING CURRENT RANGE	10-250A
TIG DUTY CYCLE @ 40°C	30% @ 250A
TIG WELDING THICKNESS RANGE	1mm - 6mm

STICK SPECIFICATIONS	
STICK WELDING CURRENT RANGE	10-250A
STICK DUTY CYCLE @ 40°C	30% @ 250A
STICK ELECTRODE RANGE	2.5-4.0mm
STICK WELDING THICKNESS RANGE	2mm - 12mm

SIZE & WEIGHT	
DIMENSIONS (mm)	585x280x440mm
WEIGHT (kg)	30kg

MACHINE FEATURES	
WIRE DRIVE	Geared
VRD	Yes
SPOOL GUN CONNECTION	Yes
BURNBACK ADJUSTMENT	Yes
WIRE INCH	Yes
INDUCTANCE CONTROL	Yes
THERMAL OVERLOAD PROTECTION	Over Temperature Warning



1. Power LED
2. Voltage Display
3. Thermal Overload LED
4. Voltage Control Knob
5. Amperage Control Knob
6. Positive Output Socket
7. Euro MIG Torch Connector
8. Negative Output Socket
9. Amperage Display
10. VRD LED
11. Wire Feed Adjustment Knob
12. Inductance Control
13. MIG/TIG/MMA Selector
14. MIG / Spool Gun Selector
15. Spool Gun Connection



16. Power Switch
17. Gas Inlet
18. Power Cable
19. Data Plate

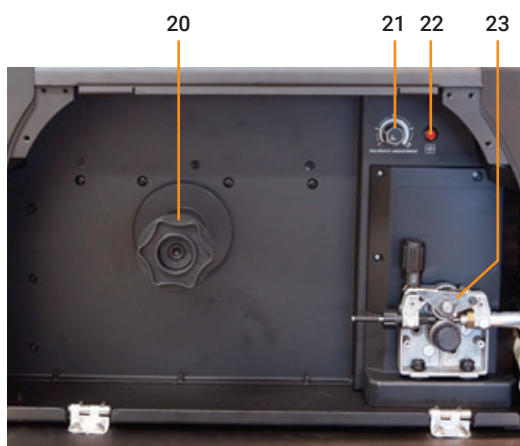

20. Wire Spool Holder
21. Burn Back Adjustment
22. Wire Inch Button
23. Geared Wire Drive



1. Select the MIG function with the MIG/MMA selector switch.
2. Select **Standard** using the Standard/Spool Gun selector switch.
3. Connect the welding torch into the Euro Mig torch connection socket on the front panel, and tighten it.
4. Insert the earth cable plug into the required polarity and tighten - negative (-) for gas shielded wires, positive (+) for gas less wires. The weld power cable goes into the opposing negative (-) or positive (+) socket.
5. Connect Gas Line to Gas Regulator and connect the gas regulator to the Gas Cylinder.

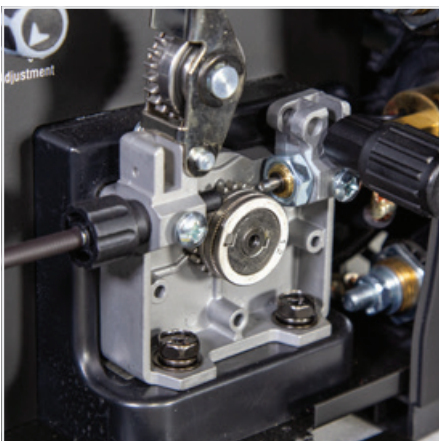

(6) Fit the correct type and size of drive rollers. V Groove for Hard Wires. U Groove for Aluminium. Knurled for Flux Cored



(7) Place wire onto spool holder - (spool retaining nut is left hand thread) Feed the wire through the inlet guide tube into the drive roller.

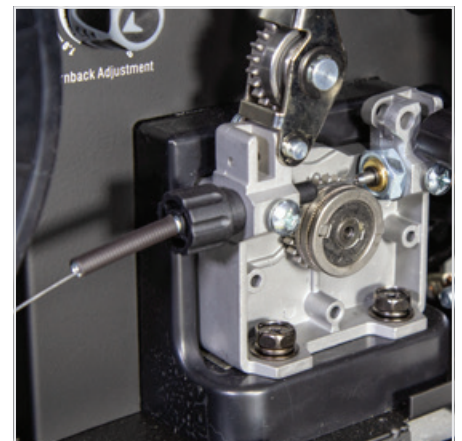

(8) Feed wire over the drive roller into the outlet guide tube, Push the wire through approx 150mm.

MIG WITH GAS INSTALLATION

UNIMIG

BUILT FOR WELDERS

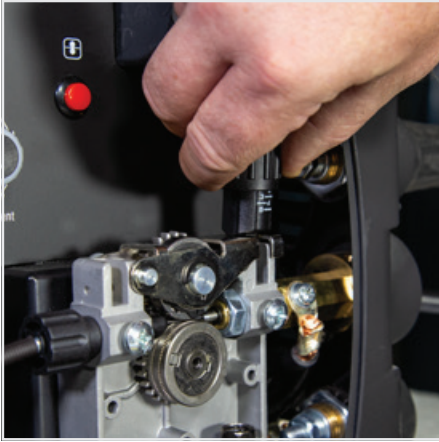

(9) Close down the top roller bracket and clip the pressure arm into place. Apply a medium amount of pressure to the drive roller

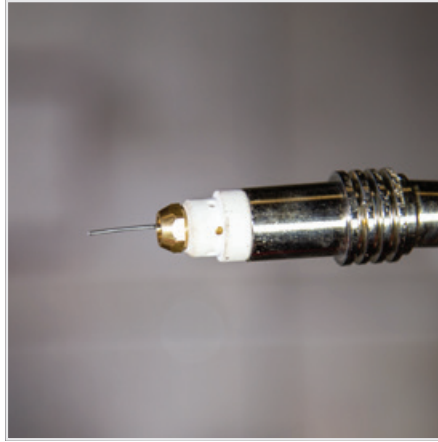

(10) Remove the gas nozzle and contact tip from the front end of the MIG torch.



(11) Press and hold the inch wire button to feed the wire down the torch cable through to the torch head.



(12) Fit the correct size contact tip over the wire and fasten tightly into the tip holder.



(13) Fit the gas nozzle to the torch head.



(14) Carefully open the valve of the gas cylinder, set the flow to 8-10 L/min



(15) Set welding parameters using the voltage and wire feed controls.



(16) Adjust the burn back control to prevent the wire sticking in the weld pool. Burn back control is located above the wire feed motor



1. Select the MIG function with the MIG/MMA selector switch.
2. Select **Standard** using the Standard/Spool Gun selector switch (Inside machine).
3. Connect the weld power cable to the Negative socket and tighten it.
4. Connect the earth cable plug into the Positive socket and tighten it.
5. Connect the welding torch into the Euro Mig torch connection socket on the front panel, and tighten it.

IMPORTANT : When connecting the torch be sure to tighten the connection. A loose connection can result in the connector arcing and damaging the machine and gun connector. This damage is not covered under warranty.

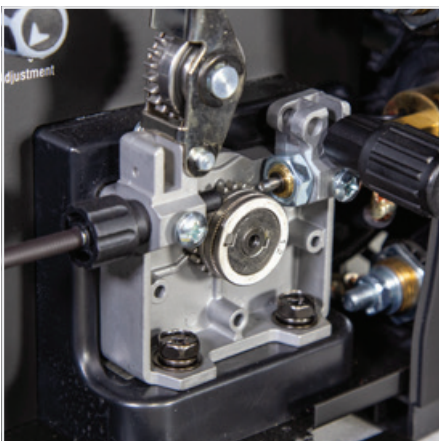

(6) Fit the correct size Knurled drive roller for Gas Less Flux Core wire



(7) Place wire onto spool holder - (spool retaining nut is left hand thread) Feed the wire through the inlet guide tube into the drive roller.

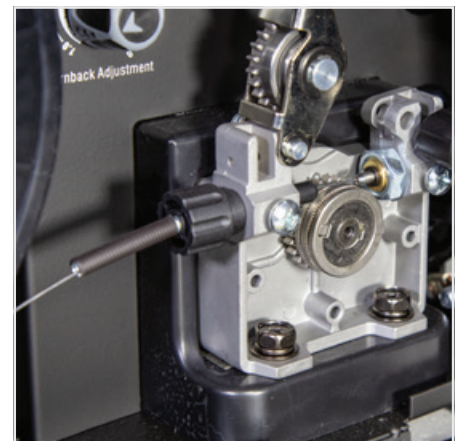

(8) Feed wire over the drive roller into the outlet guide tube, Push the wire through approx 150mm.

GASLESS MIG INSTALLATION

UNIMIG

BUILT FOR WELDERS

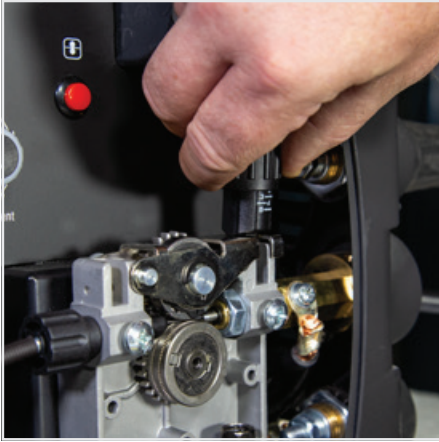

(9) Close down the top roller bracket and clip the pressure arm into place. Apply a medium amount of pressure to the drive roller.



(10) Apply a medium amount of pressure to the drive roller.



(11) Remove the gas nozzle and contact tip from the front end of the MIG torch.



(12) Press and hold the inch wire button to feed the wire down the torch cable through to the torch head.



(13) Fit the correct size contact tip over the wire and fasten tightly into the tip holder.



(14) Fit the gas nozzle to the torch head.



(15) Set welding parameters using the voltage and wire feed controls.



(16) Adjust the burn back control to prevent the wire sticking in the weld pool. Burn back control is located above the wire feed motor.

The importance of smooth consistent wire feeding during MIG welding cannot be emphasized enough.

Simply put the smoother the wire feed then the better the welding will be.

Feed rollers or drive rollers are used to feed the wire mechanically along the length of the welding gun.

Feed rollers are designed to be used for certain types of welding wire and they have different types of grooves machined in them to accommodate the different types of wire. The wire is held in the groove by the top roller of the wire drive unit and is referred to as the pressure roller, pressure is applied by a tension arm that can be adjusted to increase or decrease the pressure as required. The type of wire will determine how much pressure can be applied and what type of drive roller is best suited to obtain optimum wire feed.

Solid Hard Wire - like Steel, Stainless Steel require a drive roller with a V shape groove for optimum grip and drive capability. Solid wires can have more tension applied to the wire from the top pressure roller that holds the wire in the groove and the V shape groove is more suited for this. Solid wires are more forgiving to feed due to their higher cross sectional column strength, they are stiffer and don't bend so easy.

Soft Wire - like Aluminium requires a U shape groove. Aluminium wire has a lot less column strength, can bend easily and is therefore more difficult to feed. Soft wires can easily buckle at the wire feeder where the wire is fed into inlet guide tube of the torch. The U-shaped roller offers more surface area grip and traction to help feed the softer wire. Softer wires also require less tension from the top pressure roller to avoid deforming the shape of the wire, too much tension will push the wire out of shape and cause it to catch in the contact tip.

Flux Core / Gasless Wire - these wires are made up of a thin metal sheath that has fluxing and metal compounds layered onto it and then rolled into a cylinder to form the finished wire. The wire cannot take too much pressure from the top roller as it can be crushed and deformed if too much pressure is applied. A knurled drive roller has been developed and it has small serrations in the groove, the serrations grip the wire and assist to drive it without too much pressure from the top roller. The down side to the knurled wire feed roller on flux cored wire is it will slowly over time bit by bit eat away at the surface of the welding wire, and these small pieces will eventually go down into the liner. This will cause clogging in the liner and added friction that will lead to welding wire feed problems. A U groove wire can also be used for flux core wire without the wire particles coming of the wire surface. However it is considered that the knurled roller will give a more positive feed of flux core wire without any deformation of the wire shape.

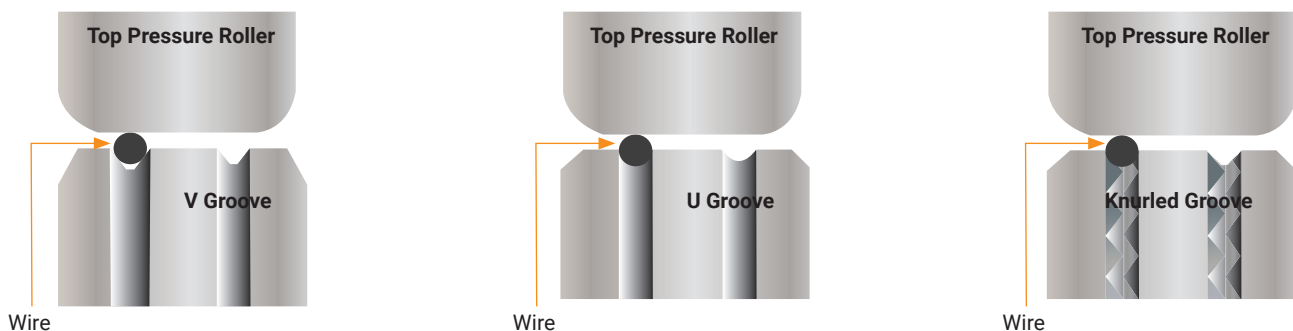

ROLLER DIAMETER: 30/22

V GROOVE DRIVE ROLLER - STEEL WIRE

Part-No	Description
0.6-0.8V30/22	Drive Roll V Groove 0.6-0.8mm
0.8-1.0V30/22	Drive Roll V Groove 0.8-1.0mm
0.9-1.2V30/22	Drive Roll V Groove 0.9-1.2mm
1.0-1.2V30/22	Drive Roll V Groove 1.0-1.2mm

KNURLED DRIVE ROLLER - FLUX CORE WIRE

Part-No	Description
0.8-0.9F30/22	Drive Roll Knurled 0.8-0.9mm
0.9-1.2F30/22	Drive Roll Knurled 0.9-1.2mm

U GROOVE DRIVE ROLLER - SOFT WIRE

Part-No	Description
0.8-1.0U30/22	Drive Roll U Groove 1.0-1.2mm
0.9-1.0U30/22	Drive Roll U Groove 0.9-1.0mm
0.9-1.2U30/22	Drive Roll U Groove 0.9-1.2mm
1.0-1.2U30/22	Drive Roll U Groove 1.0-1.2mm



Again the importance of smooth consistent wire feeding during MIG welding cannot be emphasized enough.

The correct installation of the wire spool and the wire into the wire feed unit is critical to achieving an even and consistent wire feed. A high percentage of faults with MIG welders emanate from poor set up of the wire into the wire feeder. The guide below will assist in the correct setup of your wire feeder.

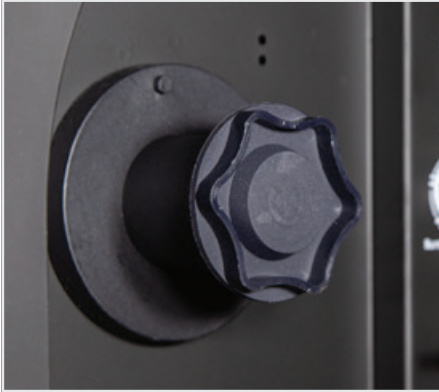

(1) Remove the spool retaining nut.

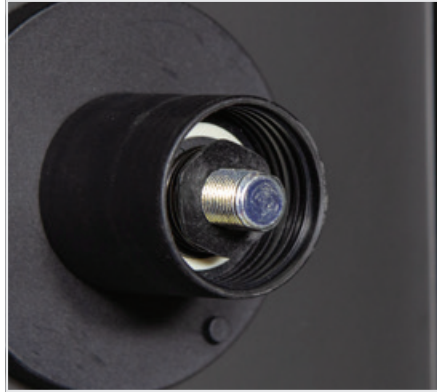

(2) Note the tension spring adjuster and spool locating pin.

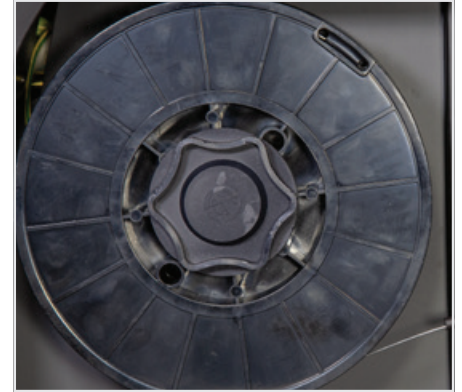

(3) Fit the wire spool onto the spool holder fitting the locating pin into the location hole on the spool. Replace the spool retaining nut tightly

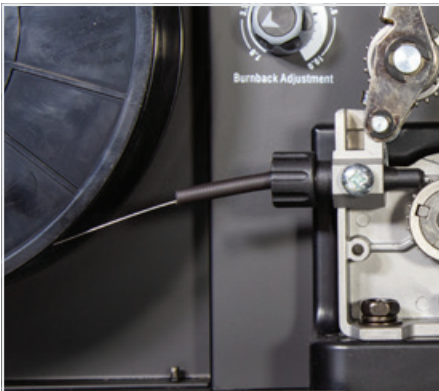

(4) Snip the wire carefully, be sure to hold the wire to prevent the spool uncoiling. Carefully feed the wire into the inlet guide tube of the wire feed unit.

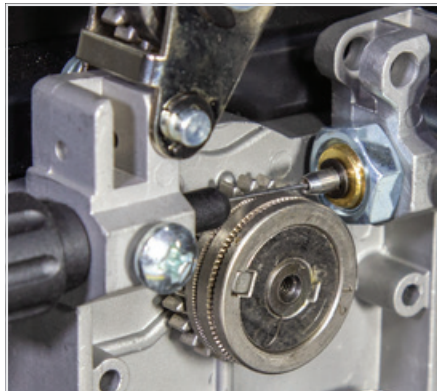

(5) Feed the wire through the drive roller and into the outlet guide tube of the wire feeder.



(6) Lock down the top pressure roller and apply a medium amount of pressure using the tension adjustment knob

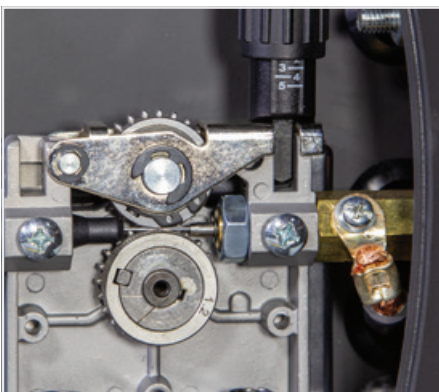

(7) Check that the wire passes through the centre of the outlet guide tube without touching the sides. Loosen the locking screw and then loosen the outlet guide tube retaining nut too make adjustment if required. Carefully re-tighten the locking nut and screw to hold the new position.

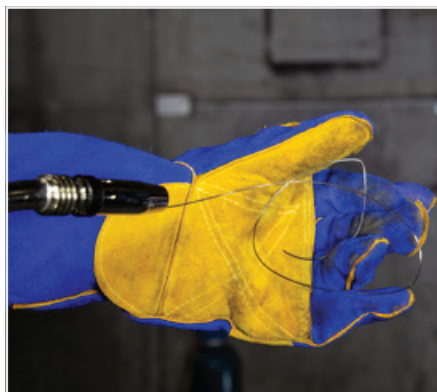

(8) A simple check for the correct drive tension is to bend the end of the wire over hold it about 100mm from your hand and let it run into your hand, it should coil round in your hand without stopping and slipping at the drive rollers, increase the tension if it slips.



(9) The weight and speed of the wire spool turning creates an inertia that can cause the spool to run on and the wire loop over the side of the spool and tangle. If this happens increase the pressure on the tension spring inside the spool holder assembly using the tension adjustment screw.

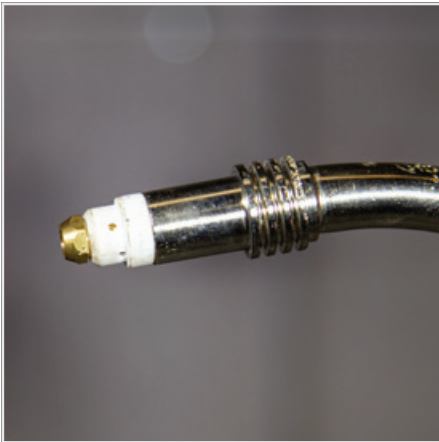

(1) Remove MIG torch front end parts

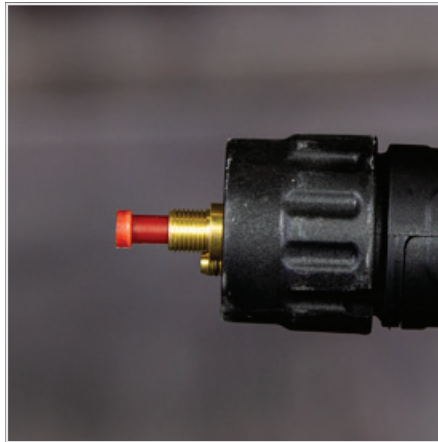

(2) Remove the liner retaining nut



(3) Carefully pull out and completely remove the liner



(4) Carefully unravel the new liner, avoiding creating any kinks in the liner.

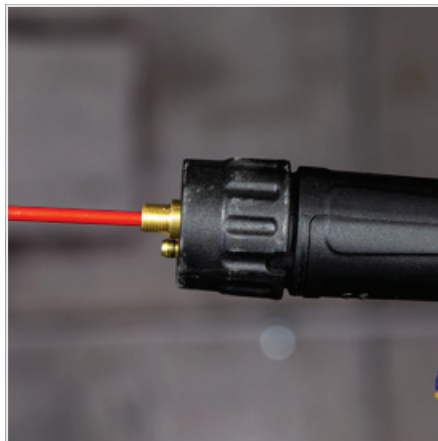

(5) Carefully feed in the new liner down the torch lead all the way to exit the torch neck.



(6) Fit the liner retaining nut and screw only 1/2 way down.

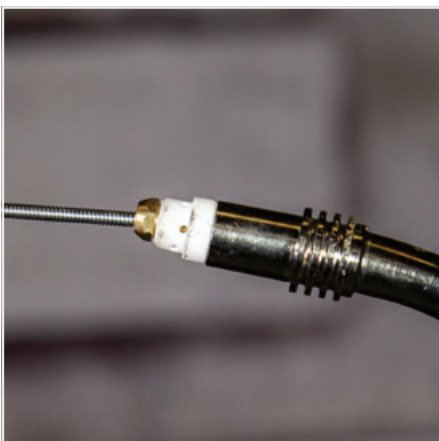

(7) Snip the liner off 3mm past the end of the torch neck.



(8) Replace the front end parts



(9) Fully screw down the liner retaining nut and nip it up tight. This compresses the liner inside the torch cable assembly preventing it moving during use and ensures good wire feed.

TORCH & WIRE FEED SET UP FOR ALUMINIUM WIRE

UNIMIG

BUILT FOR WELDERS

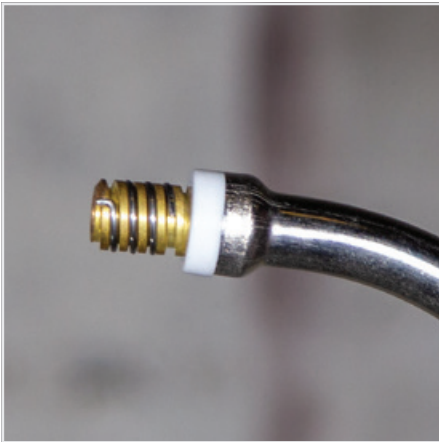

(1) Remove MIG torch front end parts

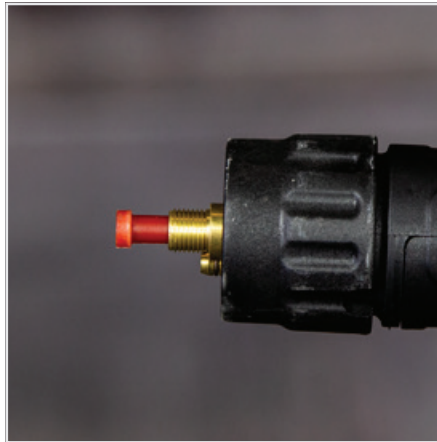

(2) Remove the liner retaining nut



(3) Carefully pull out and completely remove the liner



(4) Carefully unravel the new liner

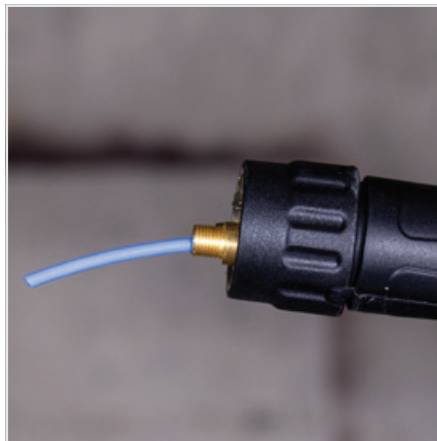

(5) Carefully feed in the new liner in short forward movements down the torch lead all the way to exit the torch neck. Be careful not to kink the liner



(6) Replace the front end parts

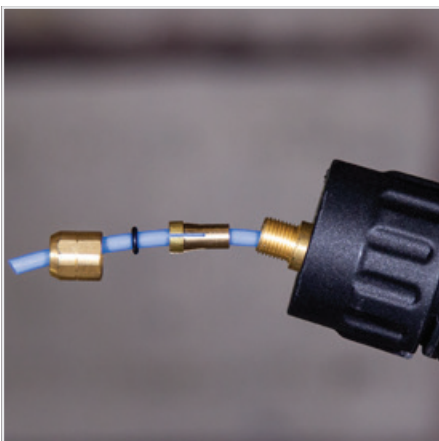

(7) Fit the liner collet, liner O-ring and liner retaining nut.

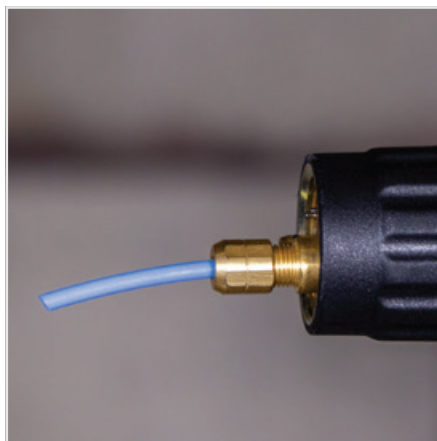

(8) Push the liner firmly into the torch lead and tighten the liner retaining nut



(9) Install a U groove drive roller of the correct size for the diameter wire being used.

TORCH & WIRE FEED SET UP FOR ALUMINIUM WIRE

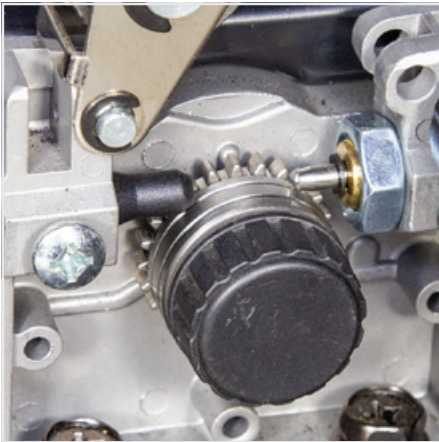

(10) Loosen the inlet guide tube retaining screw.



(11) Remove the inlet guide tube using long nose pliers.



(12) Carefully feed the Polymide liner into the inlet guide tube hole of the torch Euro receptacle

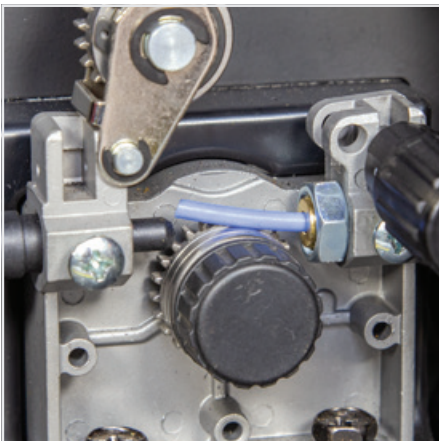

(13) Take the extended Polymide liner all the way up and over the drive roller



(14) Tighten and secure the torch Euro connector to the machine Euro receptacle

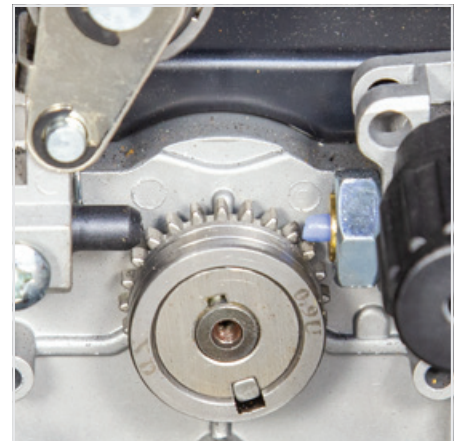

(15) Cut the extended Polymide liner with a sharp Stanley knife just in front of the drive roller



(16) Fit an Aluminium contact tip of the correct size to match the wire diameter being used



(17) Fit the remaining front end parts to the torch neck ready for welding.

MIG (Metal Inert Gas) Welding

Definition of MIG Welding - MIG (metal inert gas) welding also known as GMAW (gas metal arc welding) or MAG (metal active gas welding), is a semi-automatic or automatic arc welding process in which a continuous and consumable wire electrode and a shielding gas are fed through a welding gun. A constant voltage, direct current power source is most commonly used with MIG welding. There are four primary methods of metal transfer in MIG welding, called short circuit (also known as dip transfer) globular transfer, spray transfer and pulsed-spray, each of which has distinct properties and corresponding advantages and limitations. To perform MIG welding, the basic necessary equipment is a welding gun, a wire feed unit, a welding power supply, an electrode wire, and a shielding gas supply. Short circuit transfer is the most common used method whereby the wire electrode is fed continuously down the welding torch through to and exiting the contact tip. The wire touches the work piece and causes a short circuit the wire heats up and begins to form a molten bead, the bead separates from the end of the wire and forms a droplet that is transferred into the weld pool. This process is repeated about 100 times per second, making the arc appear constant to the human eye.

MIG Circuit Diagram

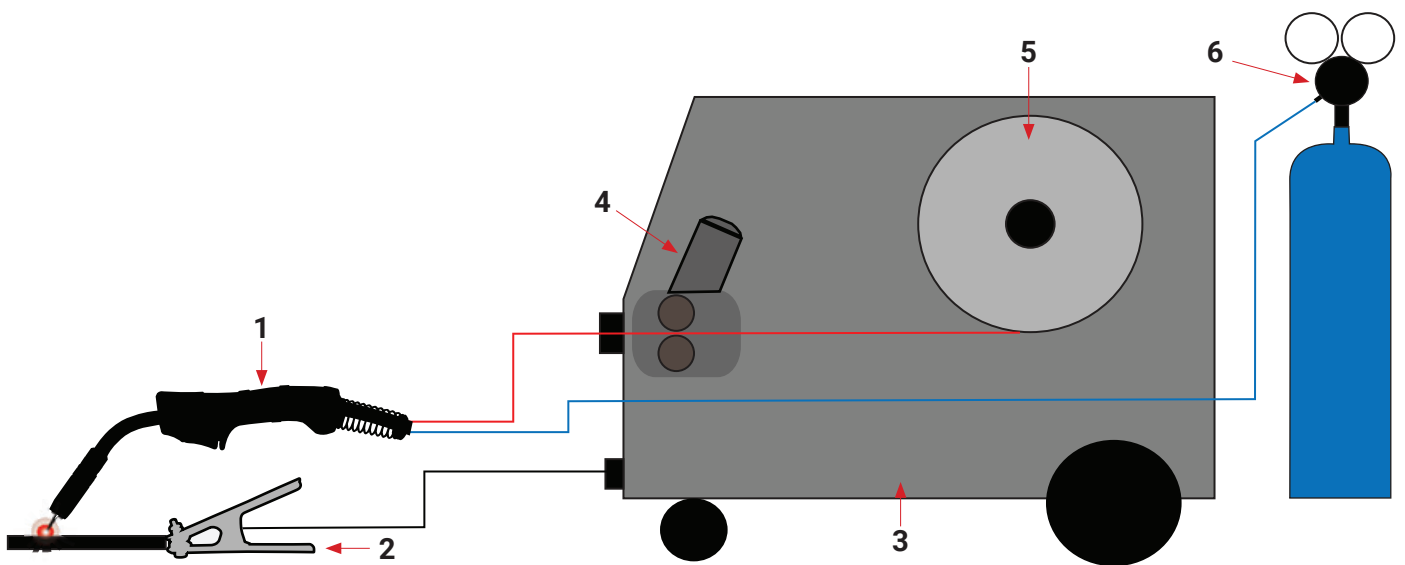

1. MIG Torch - 2. Work Piece - 3. Power Source - 4. Wire Feeder - 5. Wire Spool - 6. Gas

MIG (Metal Inert Gas) Welding

Short Circuit Transfer - Short circuit transfer is the most common used method whereby the wire electrode is fed continuously down the welding torch through to and exiting the contact tip. The wire touches the work piece and causes a short circuit the wire heats up and begins to form a molten bead, the bead separates from the end of the wire and forms a droplet that is transferred into the weld pool. This process is repeated about 100 times per second, making the arc appear constant to the human eye.

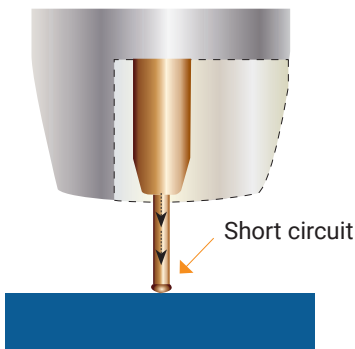

The wire approaches the work piece and touches the work creating a short circuit between the wire and the base metal, because there is no space between the wire and the base metal there is no arc and current flows through the wire.

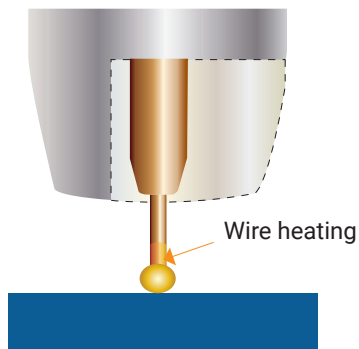

The wire cannot support all the current flow, resistance builds up and the wire becomes hot and weak and begins to melt

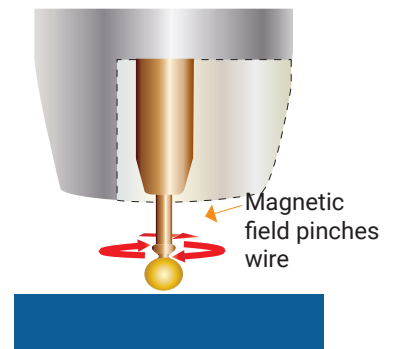

The current flow creates a magnetic field that begins to pinch the melting wire forming it into droplet

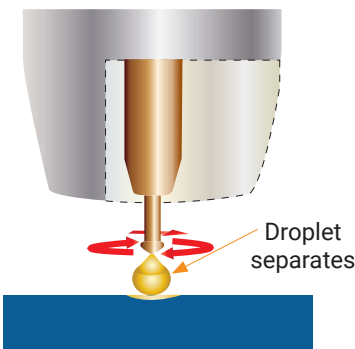

The pinch causes the forming droplet to separate and fall towards the now creating weld pool.

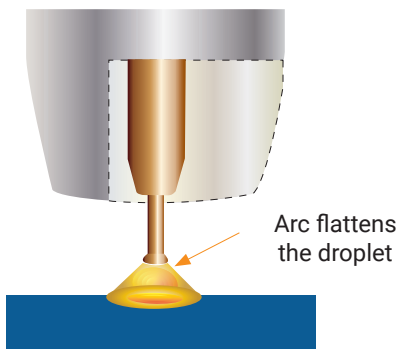

An arc is created at the separation of the droplet and the heat and force of the arc flattens out the droplet into the weld pool. The heat of the arc melts the end of the wire slightly as it feeds towards the base metal

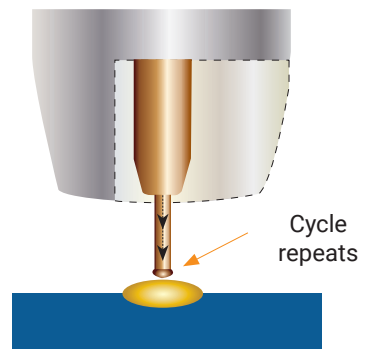

The wire feed speed overcomes the heat of the arc and the wire again approaches the work to short circuit and repeat the cycle.

Basic MIG Welding

Good weld quality and weld profile depends on gun angle, direction of travel, electrode extension (stick out), travel speed, thickness of base metal, wire feed speed (amperage) and arc voltage. To follow are some basic guides to assist with your setup.

Gun Position - Travel Direction, Work Angle

Gun position or technique usually refers to how the wire is directed at the base metal, the angle and travel direction chosen. Travel speed and work angle will determine the characteristic of the weld bead profile and degree of weld penetration.

Push Technique

The wire is located at the leading edge of the weld pool and pushed towards the un-melted work surface. This technique offers a better view of the weld joint and direction of the wire into the weld joint. Push technique directs the heat away from the weld puddle allowing faster travel speeds providing a flatter weld profile with light penetration - useful for welding thin materials. The welds are wider and flatter allowing for minimal clean up / grinding time.

Perpendicular Technique

The wire is fed directly into the weld, this technique is used primarily for automated situations or when conditions make it necessary. The weld profile is generally higher and a deeper penetration is achieved.

Drag Technique

The gun and wire is dragged away from the weld bead. The arc and heat is concentrated on the weld pool, the base metal receives more heat, deeper melting, more penetration and the weld profile is higher with more build up.

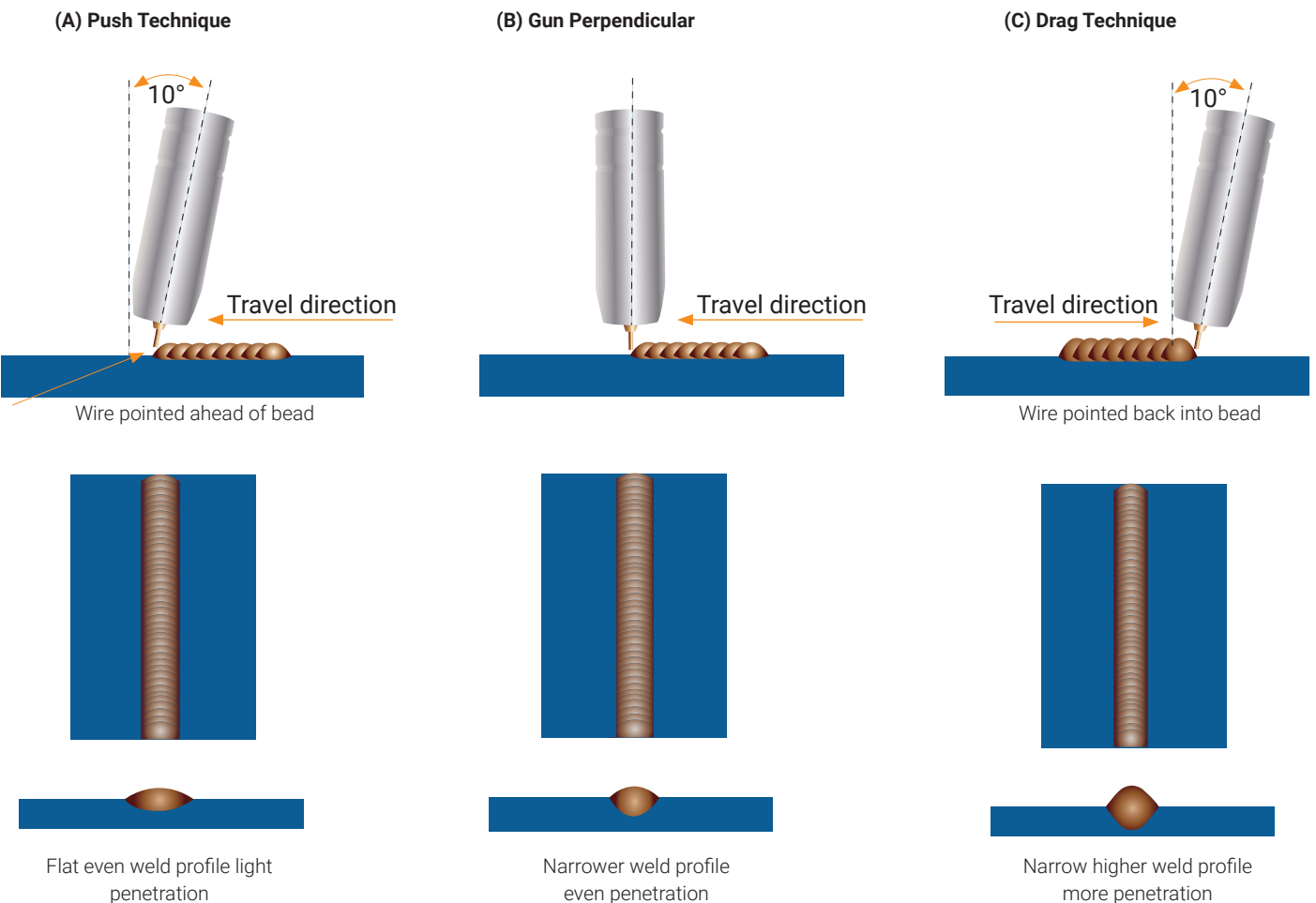

Travel Angle

Travel angle is the right to left angle relative to the direction of welding. A travel angle of 5°- 15° is ideal and produces a good level of control over the weld pool. A travel angle greater than 20° will give an unstable arc condition with poor weld metal transfer, less penetration, high levels of spatter, poor gas shield and poor quality finished weld.

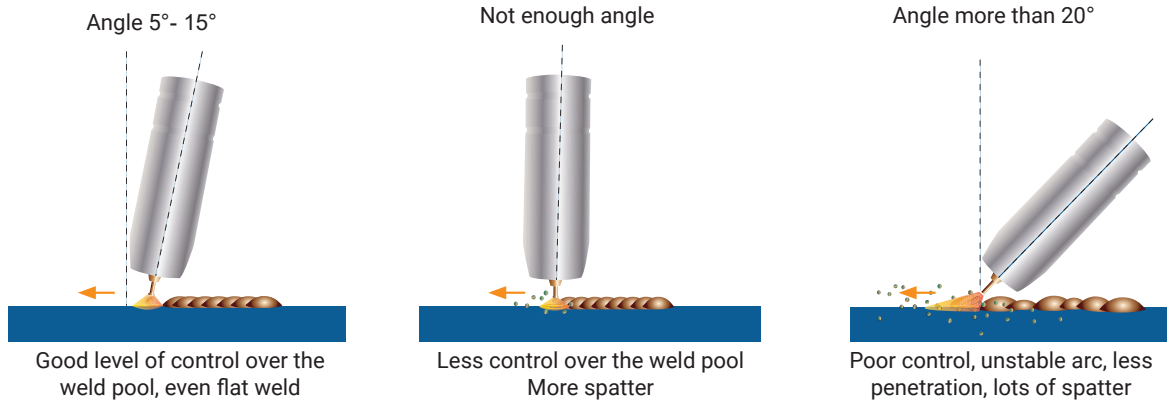

Angle to Work

The work angle is the forward back angle of the gun relative to the work piece.

The correct work angle provides good bead shape, prevents undercut, uneven penetration, poor gas shield and poor quality finished weld.

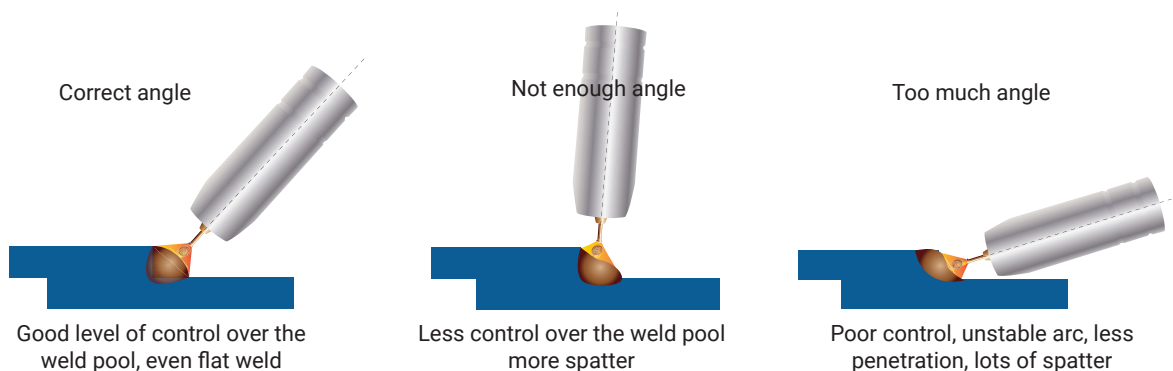

Stick Out

Stick out is the length of the unmelted wire protruding from the end of the contact tip.

A constant even stick out of 5-10mm will produce a stable arc, and an even current flow providing good penetration and even fusion. Too short stick out will cause an unstable weld pool, produce spatter and over heat the contact tip. Too long stick out will cause an unstable arc, lack of penetration, lack of fusion and increase spatter.

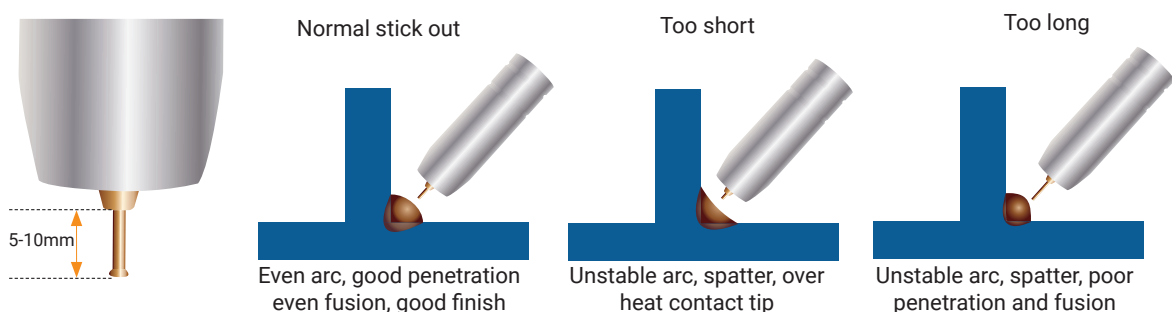

Travel Speed

Travel speed is the rate that the gun is moved along the weld joint and is usually measured in mm per minute. Travel speeds can vary depending on conditions and the welders skill and is limited to the welders ability to control the weld pool. Push technique allows faster travel speeds than Drag technique. Gas flow must also correspond with the travel speed, increasing with faster travel speed and decreasing with slower speed. Travel speed needs to match the amperage and will decrease as the material thickness and amperage increase.

Too Fast Travel Speed

A too fast travel speed produces too little heat per mm of travel resulting in less penetration and reduced weld fusion, the weld bead solidifies very quickly trapping gases inside the weld metal causing porosity. Undercutting of the base metal can also occur and an unfilled groove in the base metal is created when the travel speed is too fast to allow molten metal to flow into the weld crater created by the arc heat.

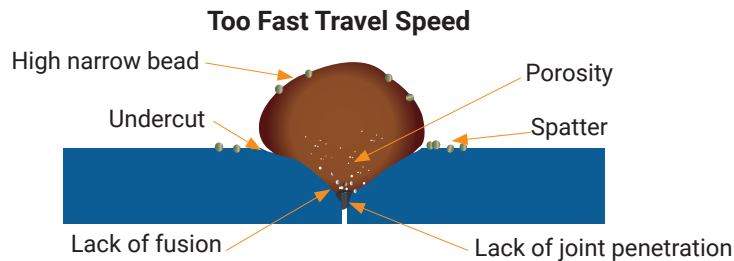

Too Slow Travel Speed

A too slow travel speed produces a large weld with lack of penetration and fusion. The energy from the arc dwells on top of the weld pool rather than penetrating the base metal. This produces a wider weld bead with more deposited weld metal per mm than is required resulting in a weld deposit of poor quality.

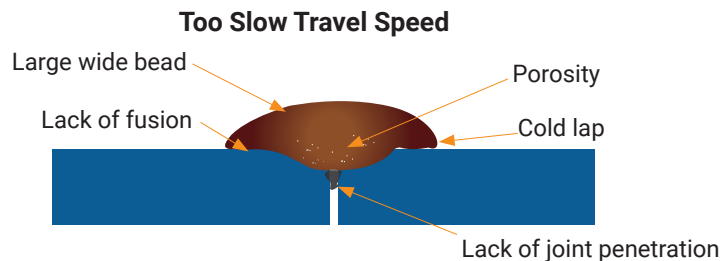

Correct Travel Speed

The correct travel speed keeps the arc at the leading edge of the weld pool allowing the base metal to melt sufficiently to create good penetration, fusion and wetting out of the weld pool producing a weld deposit of good quality.

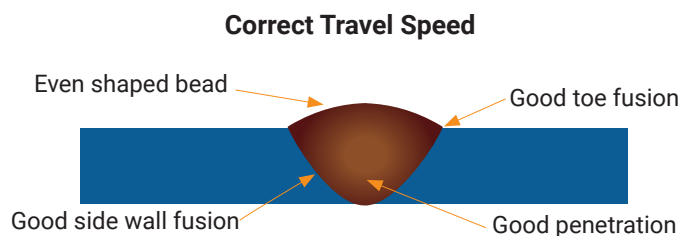

Wire types and sizes

Use the correct wire type for the base metal being welded. Use stainless steel wire for stainless steel, aluminium wires for aluminium and steel wires for steel.

Use a smaller diameter wire for thin base metals. For thicker materials use a larger wire diameter and larger machine, check the recommended welding capability of you machine.

As a guide refer to the "Welding Wire Thickness Chart" below.

WELDING WIRE DIAMETER CHART							
MATERIAL THICKNESS	RECOMMENDED WIRE DIAMETERS						
	MIG SOLID WIRE				GASLESS FLUX-CORED WIRE		
	0.6mm	0.8mm	0.9mm	1.0mm	0.8mm	0.9mm	1.2mm
24 Gauge (0.6mm)							
22 Gauge (0.75mm)							
20 Gauge (0.9mm)							
18 Gauge (1.0mm)							
16 Gauge (1.2mm)							
14 Gauge (1.9mm)							
3.0mm							
5.0mm							
6.0mm							
8.0mm							
10.0mm							
12.0mm							

For material thickness 5.0mm and greater, multi-pass runs or a bevelled joint design may be required depending on the amperage capability of your machine.

Gas selection

The purpose of the gas in the MIG process is to protect / shield the wire, the arc and the molten weld metal from the atmosphere. Most metals when heated to a molten state will react with the air in the atmosphere, without the protection of the shielding gas the weld produced would contain defects like porosity, lack of fusion and slag inclusions. Additionally some of the gas becomes ionised (electrically charged) and helps the current flow smoothly.

The correct gas flow is also very important in protecting the welding zone from the atmosphere.

Too low flow will give inadequate coverage and result in weld defects and unstable arc conditions.

Too high flow can cause air to be drawn into the gas column and contaminate the weld zone.

Use the correct shielding gas. Co2 is good for steel and offers good penetration characteristics, the weld profile is narrower and slightly more raised than the weld profile obtained from Argon Co2 mixed gas. Argon Co2 mix gas offers better weld ability for thin metals and has a wider range of setting tolerance on the machine. Argon 80% Co2 20% is a good all round mix suitable for most applications.

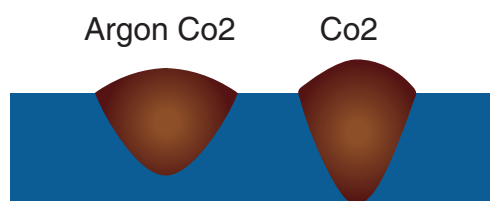

Penetration Pattern for Steel

SPOOL GUN SETUP

UNIMIG

BUILT FOR WELDERS



1. Switch on the machine, select the MIG function with the MIG/MMA selector switch.
2. Select **Spool Gun** using the Standard/Spool Gun selector switch.
3. Connect the Spool Gun to the Euro Mig torch connection socket on the front panel, and tighten it. Connect the Spool Gun control cable to the receptacle and tighten it.
4. Insert the earth cable plug into the Negative socket on the front of the machine and tighten it.
5. Connect Gas Line to Gas Regulator and connect the gas regulator to the Gas Cylinder.
6. Connect the Weld power cable to the Positive socket.



(2) Set Spool Gun / Standard selector to **Spool Gun**.



(7) Push the cover release button to unlock the wire feed /spool cover.

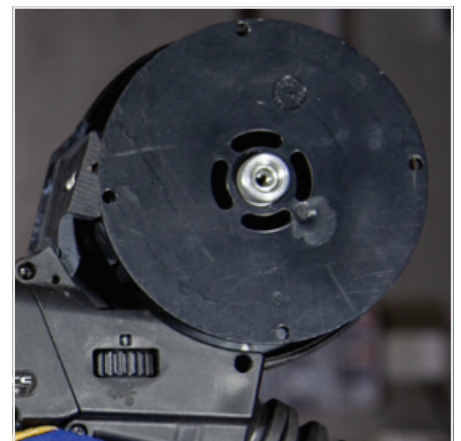

(8) Place a spool of wire onto the Spool holder. Note: the spool retaining nut is Left Hand thread, turn it clockwise to undo it.

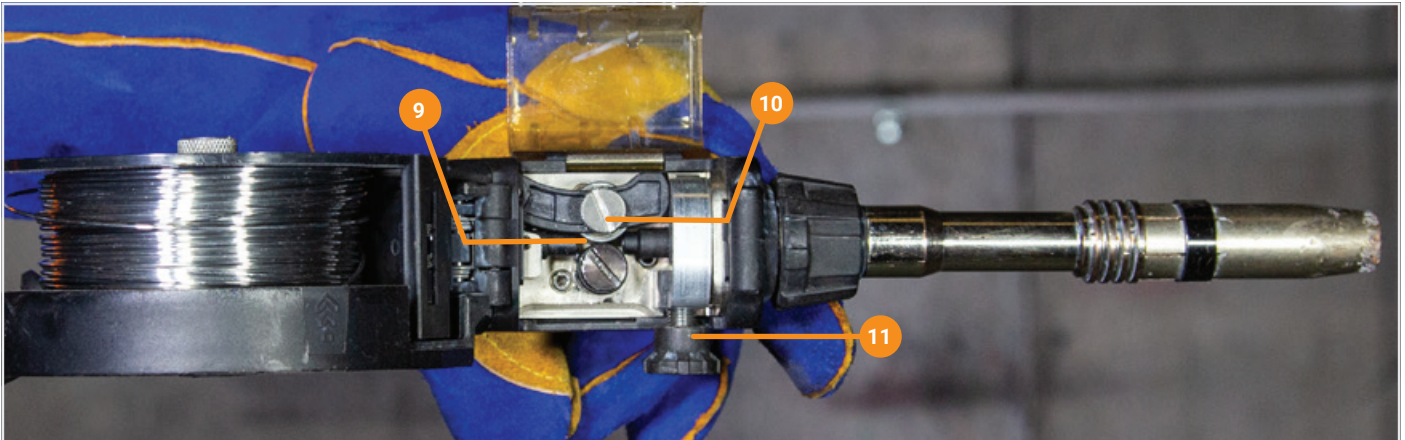

(9) Carefully feed the wire through the inlet guide tube onto the drive roller through into the outlet guide tube. Squeezing the tension arm adjustment knob to release the pressure of the tension arm will allow the wire to be guided through the drive roller easily

(10) Check to make sure that the wire passes cleanly through the drive roller into the outlet guide tube.

(11) Apply a medium amount of pressure using the tension arm adjustment knob.

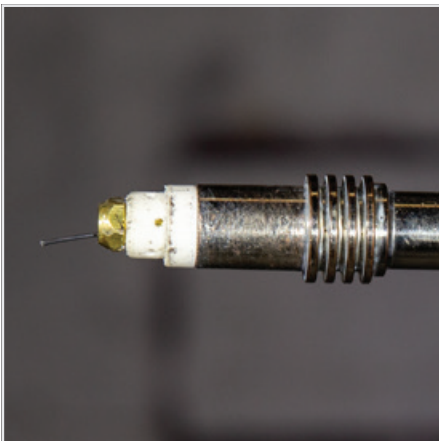

(12) Remove the gas nozzle and contact tip. Pull the trigger to drive the wire through the neck until it exits the contact tip holder

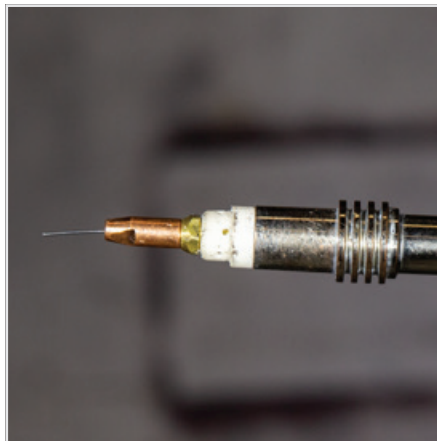

(13) Fit the contact tip over the wire and screw it into the tip holder, nip it up tight.



(14) Fit the gas nozzle and close the wire feed spool cover



(15) Carefully open the valve of the gas cylinder, set the flow to 8-12 L/min



(16) Set welding parameters using the voltage and wire feed controls.



(17) Adjust the burn back control to prevent the wire sticking in the weld pool. Burn back control is located above the wire feed motor



1. Switch on the machine, select the **TIG** function with the TIG/MMA/Mig selector switch.
2. Insert the power cable plug of the TIG torch into the Negative socket on the front of the machine and tighten it.
3. Insert the earth cable plug into the Positive socket on the front of the machine and tighten it.
4. Connect the gas line of the TIG torch to regulator and connect the regulator to the gas cylinder.



(5) Assemble front end parts of the TIG torch.



(6) Carefully open the valve of the gas cylinder, set the flow to 6-10 l/min



(7) Set the welding current using the amperage control dial.

Lift Arc ignition allows the arc to be started easily in DC TIG by simply touching the tungsten to the work piece and lifting it up to start the arc. This prevents the tungsten tip sticking to the work piece and breaking the tip from the tungsten electrode. There is a particular technique called "rocking the cup" used in the Lift Arc process that provides easy use of the Lift Arc function.

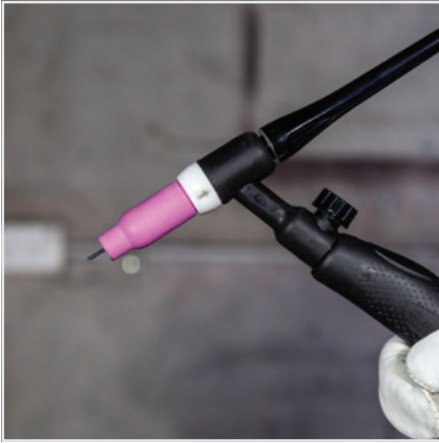

(1) Make sure the front end parts of the TIG torch are correctly assembled, use the correct size and type of tungsten electrode for the job, the tungsten electrode requires a sharpened point for DC welding.



(2) Turn on the Gas Valve located on the TIG torch handle.



(3) Lay the outside edge of the Gas Cup on the work piece with the Tungsten Electrode 1- 2mm from the work piece.



(4) With a small movement rotate the Gas Cup forward so that the Tungsten Electrode touches the work piece.



(5) Now rotate the Gas Cup in the reverse direction to lift the Tungsten electrode from the work piece to create the arc.

IMPORTANT! - We strongly recommend that you check for gas leakage prior to operation of your machine. We recommend that you close the cylinder valve when the machine is not in use.

Welding Guns Of Australia PTY LTD, authorised representatives or agents of Welding Guns Of Australia PTY LTD will not be liable or responsible for the loss of any gas.

DC TIG WELDING

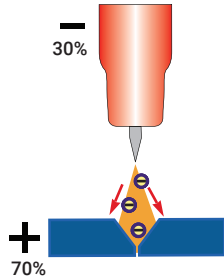

The DC power source uses what is known as DC (direct current) in which the main electrical component known as electrons flow in only one direction from the negative pole (terminal) to the positive pole (terminal). In the DC electrical circuit there is an electrical principle at work which should always be taken into account when using any DC circuit. With a DC circuit 70% of the energy (heat) is always on the positive side. This needs to be understood because it determines what terminal the TIG torch will be connected to (this rule applies to all the other forms of DC welding as well).

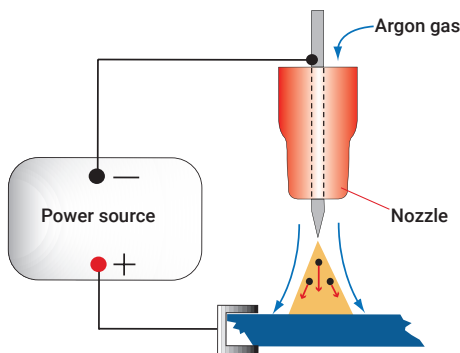

DC TIG welding is a process in which an arc is struck between a TUNGSTEN electrode and the metal work piece. The weld area is shielded by an inert gas flow to prevent contamination of the tungsten, molten pool and weld area. When the TIG arc is struck the inert gas is ionized and superheated changing its molecular structure which converts it into a plasma stream. This plasma stream flowing between the tungsten and the work piece is the TIG arc and can be as hot as 19,000°C. It is a very pure and concentrated arc which provides the controlled melting of most metals into a weld pool. TIG welding offers the user the greatest amount of flexibility to weld the widest range of material and thickness and types. DC TIG welding is also the cleanest weld with no sparks or spatter.

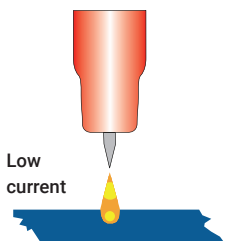

The intensity of the arc is proportional to the current that flows from the tungsten. The welder regulates the welding current to adjust the power of the arc. Typically thin material requires a less powerful arc with less heat to melt the material so less current (amps) is required, thicker material requires a more powerful arc with more heat so more current (amps) are necessary to melt the material.

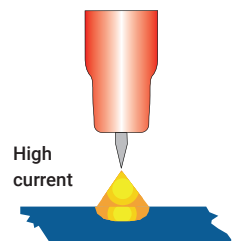

LIFT ARC IGNITION FOR TIG (TUNGSTEN INERT GAS) WELDING

Lift Arc is a form of arc ignition where the machine has low voltage on the electrode to only a few volts, with a current limit of one or two amps (well below the limit that causes metal to transfer and contamination of the weld or electrode). When the machine detects that the tungsten has left the surface and a spark is present, it immediately (within microseconds) increases power, converting the spark to a full arc. It is a simple, safe lower cost alternative arc ignition process to HF (high frequency) and a superior arc start process to scratch start.

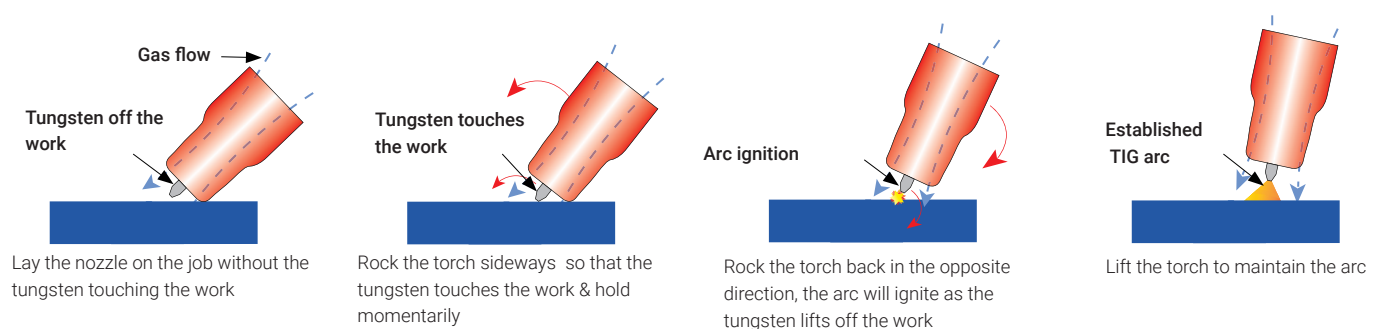

TIG WELDING FUSION TECHNIQUE

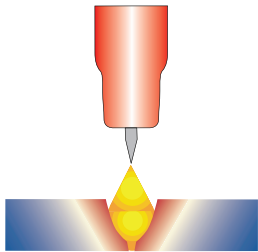

Manual TIG welding is often considered the most difficult of all the welding processes. Because the welder must maintain a short arc length, great care and skill are required to prevent contact between the electrode and the workpiece. Similar to Oxygen Acetylene torch welding, TIG welding normally requires two hands and in most instances requires the welder to manually feed a filler wire into the weld pool with one hand while manipulating the welding torch in the other. However, some welds combining thin materials can be accomplished without filler metal like edge, corner, and butt joints. This is known as Fusion welding where the edges of the metal pieces are melted together using only the heat and arc force generated by the TIG arc. Once the arc is started the torch tungsten is held in place until a weld pool is created, a circular movement of the tungsten will assist in creating a weld pool of the desired size. Once the weld pool is established tilt the torch at about a 75° angle and move smoothly and evenly along the joint while fusing the materials together.

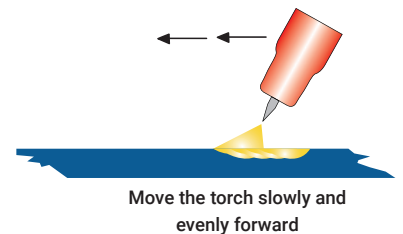
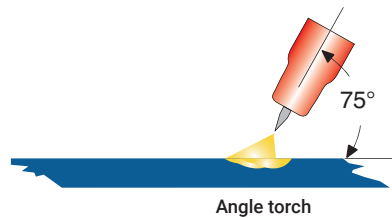
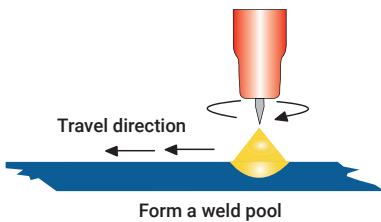

TIG WELDING WITH FILLER WIRE TECHNIQUE

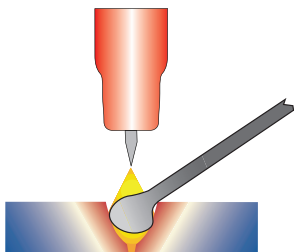

It is necessary in many situations with TIG welding to add a filler wire into the weld pool to build up weld reinforcement and create a strong weld. Once the arc is started the torch tungsten is held in place until a weld pool is created, a circular movement of the tungsten will assist in creating a weld pool of the desired size. Once the weld pool is established tilt the torch at about a 75° angle and move smoothly and evenly along the joint. The filler metal is introduced to the leading edge of the weld pool. The filler wire is usually held at about a 15° angle and fed into the leading edge of the molten pool, the arc will melt the filler wire into the weld pool as the torch is moved forward. Also a dabbing technique can be used to control the amount of filler wire added, the wire is fed into the molten pool and retracted in a repeating sequence as the torch is moved slowly and evenly forward. It is important during the welding to keep the molten end of the filler wire inside the gas shield as this protects the end of the wire from being oxidised and contaminating the weld pool.

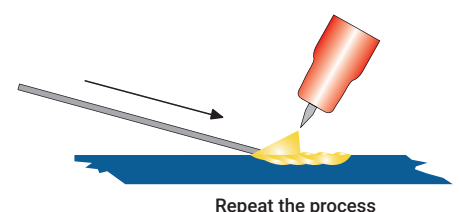
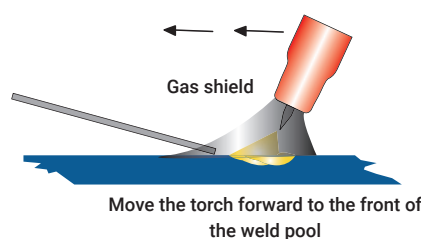
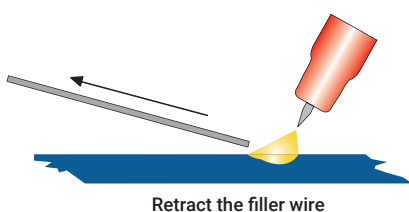
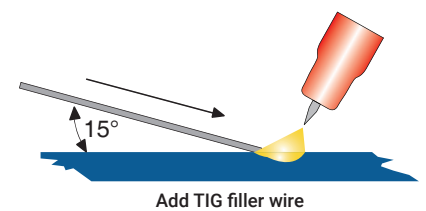
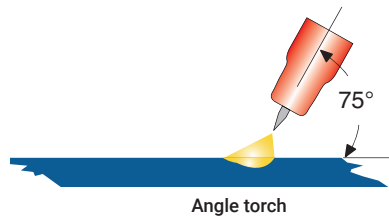
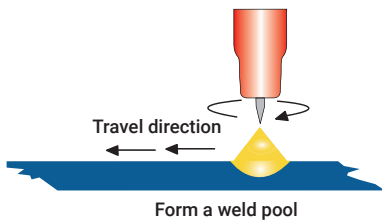

TUNGSTEN ELECTRODES

Tungsten is a rare metallic element used for manufacturing TIG welding electrodes. The TIG process relies on tungsten's hardness and high-temperature resistance to carry the welding current to the arc. Tungsten has the highest melting point of any metal, 3,410 degrees Celsius.

Tungsten electrodes are non-consumable and come in a variety of sizes, they are made from pure tungsten or an alloy of tungsten and other rare earth elements. Choosing the correct tungsten depends on the material being welded, the amount of amps required and whether you are using AC or DC welding current.

Tungsten electrodes are colour-coded at the end for easy identification.

Below are the most commonly used tungsten electrodes found in the New Zealand and Australian market.

THORIATED

Thoriated tungsten electrodes (AWS classification EWTh-2) contain a minimum of 97.30 percent tungsten and 1.70 to 2.20 percent thorium and are called 2 percent thoriated. They are the most commonly used electrodes today and are preferred for their longevity and ease of use. Thorium however is a low-level radioactive hazard and many users have switched to other alternatives. Regarding the radioactivity, thorium is an alpha emitter but when it is enclosed in a tungsten matrix the risks are negligible. Thoriated tungsten should not get in contact with open cuts or wounds. The more significant danger to welders can occur when thorium oxide gets into the lungs. This can happen from the exposure to vapours during welding or from ingestion of material/dust in the grinding of the tungsten. Follow the manufacturer's warnings, instructions, and the Material Safety Data Sheet (MSDS) for its use.

E3 (COLOUR CODE: PURPLE)

E3 tungsten electrodes (AWS classification EWG) contain a minimum of 98% percent tungsten and up to 1.5 percent Lanthanum and small percentages of Zirconium and Yttrium they are called E3 Tungsten. E3 Tungsten Electrodes provide conductivity similar to that of thoriated electrodes. Typically, this means that E3 Tungsten Electrodes are exchangeable with thoriated electrodes without requiring significant welding process changes. E3 deliver superior arc starting, electrode lifetime, and overall cost-effectiveness. When E3 Tungsten Electrodes are compared with 2% thoriated tungsten, E3 requires fewer re-grinds and provides a longer overall lifetime. Tests have shown that ignition delay with E3 Tungsten Electrodes actually improves over time, while 2% thoriated tungsten starts to deteriorate after only 25 starts. At equivalent energy output, E3 Tungsten Electrodes run cooler than 2% thoriated tungsten, thereby extending overall tip lifetime. E3 Tungsten Electrodes work well on AC or DC. They can be used DC electrode positive or negative with a pointed end, or balled for use with AC power sources.

CERIATED (COLOUR CODE: ORANGE)

Ceriated tungsten electrodes (AWS classification EWCe-2) contain a minimum of 97.30 percent tungsten and 1.80 to 2.20 percent cerium and are referred to as 2 percent ceriated. Ceriated tungstens perform best in DC welding at low current settings. They have excellent arc starts at low amperages and become popular in such applications as orbital tube welding, thin sheet metal work. They are best used to weld carbon steel, stainless steel, nickel alloys, and titanium, and in some cases it can replace 2 percent thoriated electrodes. Ceriated tungsten is best suited for lower amperages it should last longer than Thoriated tungsten higher amperage applications are best left to Thoriated or Lanthanated tungsten.

LANTHANATED (COLOUR CODE: GOLD)

Lanthanated tungsten electrodes (AWS classification EWL-1.5) contain a minimum of 97.80 percent tungsten and 1.30 percent to 1.70 percent lanthanum, and are known as 1.5 percent lanthanated. These electrodes have excellent arc starting, a low burn off rate, good arc stability, and excellent re-ignition characteristics. Lanthanated tungstens also share the conductivity characteristics of 2 percent thoriated tungsten. Lanthanated tungsten electrodes are ideal if you want to optimise your welding capabilities. They work well on AC or DC electrode negative with a pointed end, or they can be balled for use with AC sine wave power sources. Lanthanated tungsten maintains a sharpened point well, which is an advantage for welding steel and stainless steel on DC or AC from square wave power sources.

ZIRCONIATED (COLOUR CODE: WHITE)

Zirconiated tungsten electrodes (AWS classification EWZr-1) contain a minimum of 99.10 percent tungsten and 0.15 to 0.40 percent zirconium. Most commonly used for AC welding Zirconiated tungsten produces a very stable arc and is resistant to tungsten spitting. It is ideal for AC welding because it retains a balled tip and has a high resistance to contamination. Its current-carrying capacity is equal to or greater than that of thoriated tungsten. Zirconiated tungsten is not recommended for DC welding.

TUNGSTEN ELECTRODES RATING FOR WELDING CURRENTS

Tungsten Diameter (mm)	Diameter at the Tip (mm)	Constant Included Angle (°)	Current Range (Amps)	Current Range (Pulsed Amps)
1.0mm	0.25	20	11079	22037
1.6mm	0.5	25	18476	05 - 100
1.6mm	0.8	30	25842	10 - 140
2.4mm	0.8	35	33208	12 - 180
2.4mm	1.1	45	15 - 150	15 - 250
3.2mm	1.1	60	20 - 200	20 - 300
3.2mm	1.5	90	25 - 250	25 - 350

TUNGSTEN PREPARATION

Always use DIAMOND wheels when grinding and cutting. While tungsten is a very hard material, the surface of a diamond wheel is harder, and this makes for smooth grinding. Grinding without diamond wheels, such as aluminium oxide wheels, can lead to jagged edges, imperfections, or poor surface finishes not visible to the eye that will contribute to weld inconsistency and weld defects.

Always ensure to grind the tungsten in a longitudinal direction on the grinding wheel. Tungsten electrodes are manufactured with the molecular structure of the grain running lengthwise and thus grinding crosswise is "grinding against the grain." If electrodes are ground crosswise, the electrons have to jump across the grinding marks and the arc can start before the tip and wander. Grinding longitudinally with the grain, the electrons flow steadily and easily to the end of the tungsten tip. The arc starts straight and remains narrow, concentrated, and stable.



ELECTRODE TIP/FLAT

The shape of the tungsten electrode tip is an important process variable in precision arc welding. A good selection of tip/flat size will balance the need for several advantages. The bigger the flat, the more likely arc wander will occur and the more difficult it will be to arc start. However, increasing the flat to the maximum level that still allows arc start and eliminates arc wander will improve the weld penetration and increase the electrode life. Some welders still grind electrodes to a sharp point, which makes arc starting easier. However, they risk decreased welding performance from melting at the tip and the possibility of the point falling off into the weld pool.



ELECTRODE INCLUDED ANGLE/TAPER - DC WELDING

Tungsten electrodes for DC welding should be ground longitudinally and concentrically with diamond wheels to a specific included angle in conjunction with the tip/flat preparation. Different angles produce different arc shapes and offer different weld penetration capabilities. In general, blunter electrodes that have a larger included angle provide the following benefits:

- Last Longer
- Have better weld penetration
- Have a narrower arc shape
- Can handle more amperage without eroding.

Sharper electrodes with smaller included angle provide:

- Offer less arc weld
- Have a wider arc
- Have a more consistent arc

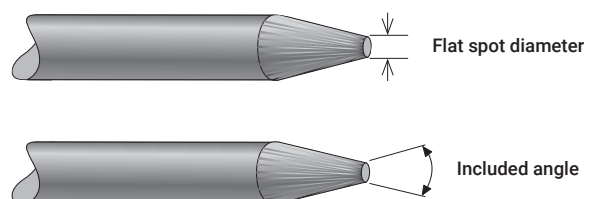

The included angle determines weld bead shape and size. Generally, as the included angle increases, penetration increases and bead width decreases.

MMA (STICK) WELDING SET UP

1. Turn the power source on and select the MMA function with the MIG/MMA selector switch.

2. Connection of Output Cables

Two sockets are available on this welding machine. For MMA welding the electrode holder is shown be connected to the positive socket, while the earth lead (work piece) is connected to the negative socket, this is known as DC+ polarity. However various electrodes require a different polarity for optimum results and careful attention should be paid to the polarity, refer to the electrode manufacturers information for the correct polarity.

DC+ Electrode connected to \oplus output socket.

DC- Electrode connected to \ominus output socket.



(3) Set the welding current using the amperage control dial.



(4) Place the electrode into the electrode holder and clamp tight.



(5) Strike the electrode against the work-piece to create an arc and hold the electrode steady to maintain the arc.



(6) Hold the electrode slightly above the work maintaining the arc while travelling at an even speed.



(7) To finish the weld, break the arc by quickly snapping the electrode away from the work piece.



(8) Wait for the weld to cool and carefully chip away the slag to reveal the weld metal below.

MMA (MANUAL METAL ARC) WELDING

One of the most common types of arc welding is manual metal arc welding (MMA) or MMA welding. An electric current is used to strike an arc between the base material and a consumable electrode rod or 'stick'. The electrode rod is made of a material that is compatible with the base material being welded and is covered with a flux that gives off gaseous vapours that serve as a shielding gas and providing a layer of slag, both of which protect the weld area from atmospheric contamination. The electrode core itself acts as filler material the residue from the flux that forms a slag covering over the weld metal must be chipped away after welding.

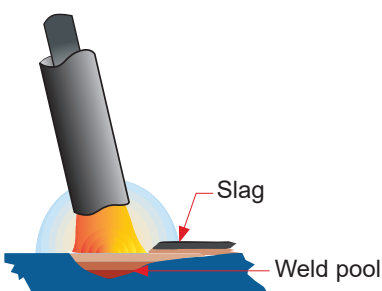
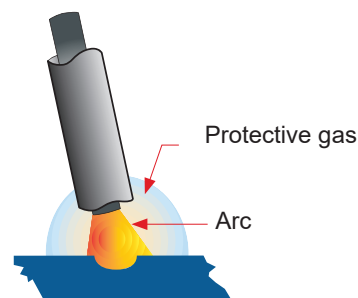
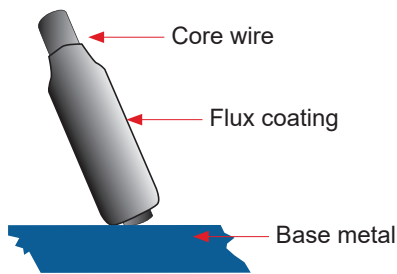
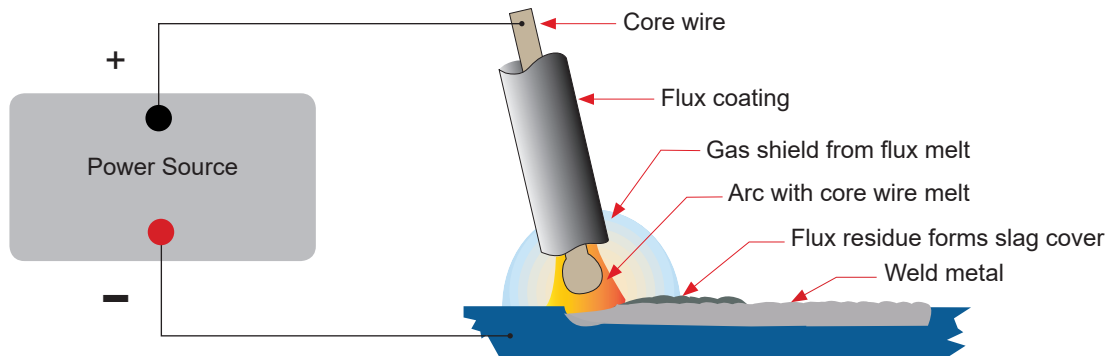

- The arc is initiated by momentarily touching the electrode to the base metal.
- The heat of the arc melts the surface of the base metal to form a molten pool at the end of the electrode.
- The melted electrode metal is transferred across the arc into the molten pool and becomes the deposited weld metal.
- The deposit is covered and protected by a slag which comes from the electrode coating.
- The arc and the immediate area are enveloped by an atmosphere of protective gas

Manual metal arc (stick) electrodes have a solid metal wire core and a flux coating. These electrodes are identified by the wire diameter and by a series of letters and numbers. The letters and numbers identify the metal alloy and the intended use of the electrode.

The Metal Wire Core works as conductor of the current that maintains the arc. The core wire melts and is deposited into the welding pool.

The covering on a shielded metal arc welding electrode is called Flux. The flux on the electrode performs many different functions.

- These include:
- Producing a protective gas around the weld area
- Providing fluxing elements and de-oxidisers
- Creating a protective slag coating over the weld as it cools
- Establishing arc characteristics
- Adding alloying elements.

Covered electrodes serve many purposes in addition to adding filler metal to the molten pool. These additional functions are provided mainly by the covering on the electrode.

MMA (STICK) WELDING FUNDAMENTALS

ELECTRODE SELECTION

As a general rule, the selection of an electrode is straight forward, in that it is only a matter of selecting an electrode of similar composition to the parent metal. However, for some metals there is a choice of several electrodes, each of which has particular properties to suit specific classes of work. It is recommended to consult your welding supplier for the correct selection of electrode.

Average Thickness of Material	Maximum Recommended Electrode Diameter
1.0 - 2.0mm	2.5mm
2.0 - 5.0mm	3.2mm
5.0 - 8.0mm	4.0mm
8.0 - > mm	5.0mm

Electrode Size (ø mm)	Current Range (Amps)
2.5mm	60 - 100
3.2mm	100 - 130
4.0mm	130 - 165
5.0mm	165 - 260

The size of the electrode generally depends on the thickness of the section being welded, and the thicker the section the larger the electrode required. The table gives the maximum size of electrodes that may be used for various thicknesses of section based on using a general purpose type 6013 electrode.

Correct current selection for a particular job is an important factor in arc welding. With the current set too low, difficulty is experienced in striking and maintaining a stable arc. The electrode tends to MMA to the work, penetration is poor and beads with a distinct rounded profile will be deposited. Too high current is accompanied by overheating of the electrode resulting in undercut and burning through of the base metal and producing excessive spatter. Normal current for a particular job may be considered as the maximum, which can be used without burning through the work, over-heating the electrode or producing a rough spattered surface. The table shows current ranges generally recommended for a general purpose type 6013 electrode.

ARC LENGTH

To strike the arc, the electrode should be gently scraped on the work until the arc is established. There is a simple rule for the proper arc length; it should be the shortest arc that gives a good surface to the weld. An arc too long reduces penetration, produces spatter and gives a rough surface finish to the weld. An excessively short arc will cause sticking of the electrode and result in poor quality welds. General rule of thumb for down hand welding is to have an arc length no greater than the diameter of the core wire.

ELECTRODE ANGLE

The angle that the electrode makes with the work is important to ensure a smooth, even transfer of metal. When welding in down hand, fillet, horizontal or overhead the angle of the electrode is generally between 5 and 15 degrees towards the direction of travel. When vertical up welding the angle of the electrode should be between 80 and 90 degrees to the work piece.

TRAVEL SPEED

The electrode should be moved along in the direction of the joint being welded at a speed that will give the size of run required. At the same time, the electrode is fed downwards to keep the correct arc length at all times. Excessive travel speeds lead to poor fusion, lack of penetration etc, while too slow a rate of travel will frequently lead to arc instability, slag inclusions and poor mechanical properties.

MATERIAL AND JOINT PREPARATION

The material to be welded should be clean and free of any moisture, paint, oil, grease, mill scale, rust or any other material that will hinder the arc and contaminate the weld material. Joint preparation will depend on the method used include sawing, punching, shearing, machining, flame cutting and others. In all cases edges should be clean and free of any contaminants. The type of joint will be determined by the chosen application.

250A AIR COOLED MIG WELDING TORCH

RATING: 250A CO² 220A MIXED GAS EN60974-7 @ 60% DUTY CYCLE. 0.8 TO 1.2MM WIRES

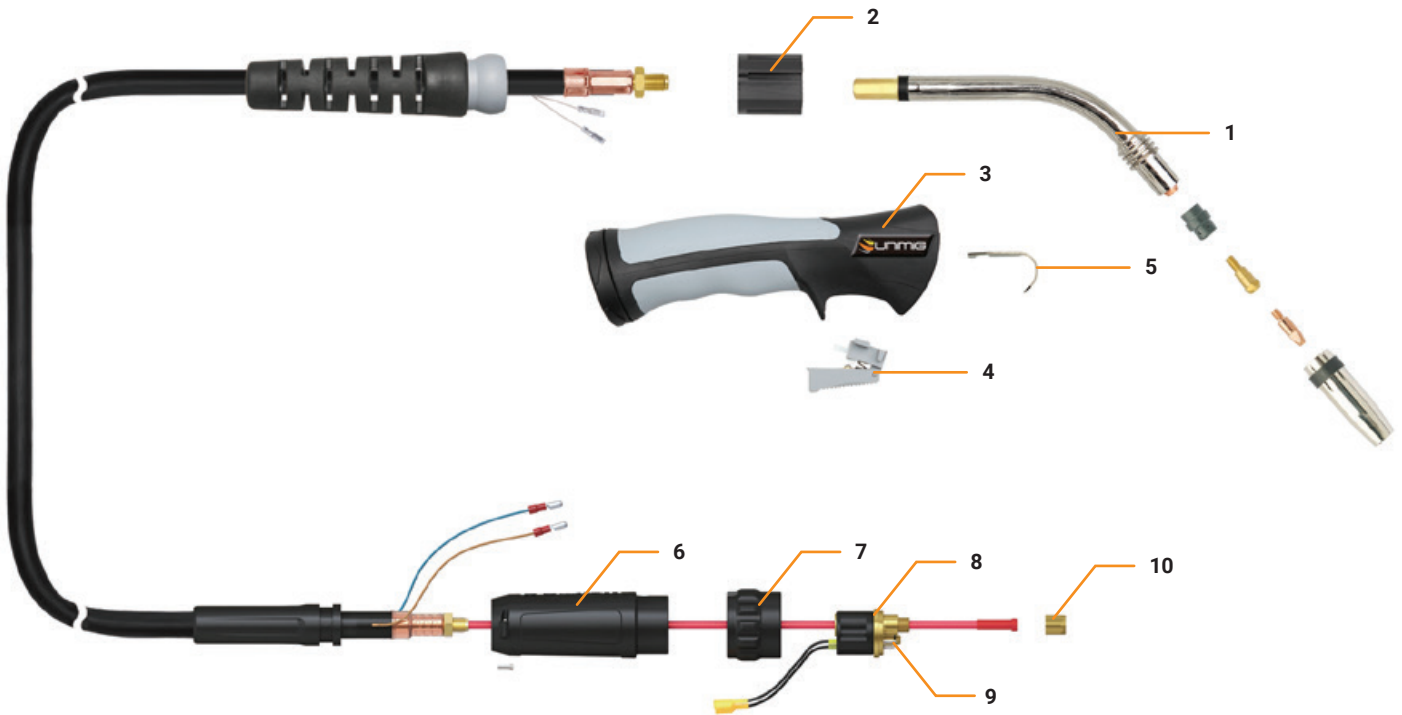

	Part No.		
Length	3m	4m	5m
SB24 SureGrip Ergo Torch Package	SB24-3M	SB24-4M	SB24-5M

Part-No	Description
1	SNK24 Swan Neck Assembly
2	UG1515 Ergo Handle Location Body
3	UG2514 Ergo Handle Kit C/W Lock Nut
4	BXU2516 Medium / Large Ergo Trigger
5	UB2517 Hanger Hook

Part-No	Description
6	UB1518 Gun Plug Housing C/W Nut
7	UB1519/S Gun Plug Nut
8	UC1528 Hybrid Gun Plug Body C/W Spring Pins
9	UB1524 Gun Plug 'O' Ring
10	UB1525 Liner Nut

FRONT END CONSUMABLES

SB24 CONTACT TIPS

Part-No	Description	QTY
PCT0009-06	Contact Tip Steel (0.6mm)	QTY10
PCT0009-08	Contact Tip Steel (0.8mm)	QTY10
PCT0009-09	Contact Tip Steel (0.9mm)	QTY10
PCT0009-10	Contact Tip Steel (1.0mm)	QTY10
PCT0009-12	Contact Tip Steel (1.2mm)	QTY10
PCT0009-16	Contact Tip Steel (1.6mm)	QTY10
PCTAL0009-09	Contact Tip Aluminium (0.9mm)	QTY10
PCTAL0009-10	Contact Tip Aluminium (1.0mm)	QTY10
PCTAL0009-12	Contact Tip Aluminium (1.2mm)	QTY10

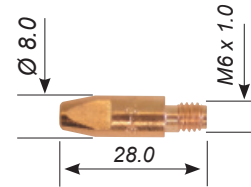

SB24 TIP HOLDER

Part-No	Description	QTY
PCTH24	Contact Tip Holder	QTY2

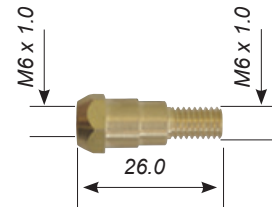

SB24 GAS DIFFUSER

Part-No	Description	QTY
PCGD24	Gas Diffuser	QTY2
PCGD24R	Rubber Gas Diffuser	QTY2

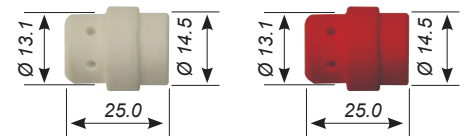

SB24 GAS NOZZLE

Part-No	Description	QTY
PGN24CYL	Cylindrical Nozzle	QTY2
PGN24CON	Conical Nozzle	QTY2
PGN24TAP	Tapered Nozzle	QTY2
PGN24SPOT	Spot Nozzle	QTY2

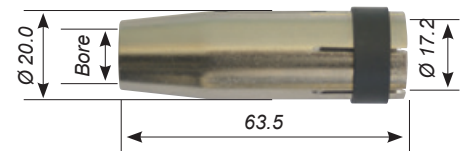

SB24 LINERS

Part-No	Description	
SLB3M	Blue Steel Liner 3 Metre	0.6 - 0.8mm
SLB4M	Blue Steel Liner 4 Metre	0.6 - 0.8mm
SLB5M	Blue Steel Liner 5 Metre	0.6 - 0.8mm
SLR3M	Red Steel Liner 3 Metre	0.9 - 1.2mm
SLR4M	Red Steel Liner 4 Metre	0.9 - 1.2mm
SLR5M	Red Steel Liner 5 Metre	0.9 - 1.2mm
TLB3M	Blue Aluminium Liner 3 Metre	0.6 - 0.8mm
TLB4M	Blue Aluminium Liner 4 Metre	0.6 - 0.8mm
TLR3M	Red Aluminium Liner 3 Metre	0.9 - 1.2mm
TLR4M	Red Aluminium Liner 4 Metre	0.9 - 1.2mm
TLY3M	Yellow Aluminium Liner 3 Metre	1.2 - 1.6mm
TLY4M	Yellow Aluminium Liner 4 Metre	1.2 - 1.6mm
NKSTL	Neck Spring for Aluminium	

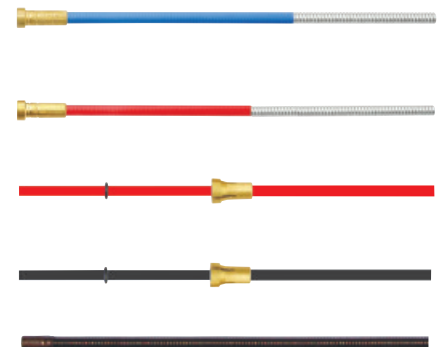

These parts are manufactured in China and are offered as replacement parts suitable for "BINZEL®" style torches.

The following chart addresses some of the common problems of MIG welding. In all cases of equipment malfunction, the manufacturer's recommendations should be strictly adhered to and followed.

1: Excessive Spatter	
Possible Reason	Suggested Remedy
Wire feed speed set too high	Select lower wire feed speed
Voltage too high	Select a lower voltage setting
Wrong polarity set	Select the correct polarity for the wire being used - see machine setup guide
Stick out too long	Bring the torch closer to the work
Contaminated base metal	Remove materials like paint, grease, oil, and dirt, including mill scale from base metal
Contaminated MIG wire	Use clean dry rust free wire. Do not lubricate the wire with oil, grease etc
Inadequate gas flow or too much gas flow	Check the gas is connected, check hoses, gas valve and torch are not restricted. Set the gas flow between 6-12 l/min flow rate. Check hoses and fittings for holes, leaks etc Protect the welding zone from wind and drafts
2: Porosity - small cavities or holes resulting from gas pockets in weld metal.	
Possible Reason	Suggested Remedy
Wrong gas	Check that the correct gas is being used
Inadequate gas flow or too much gas flow	Check the gas is connected, check hoses, gas valve and torch are not restricted. Set the gas flow between 10 - 15 l/min flow rate. Check hoses and fittings for holes, leaks etc. Protect the welding zone from wind and drafts
Moisture on the base metal	Remove all moisture from base metal before welding
Contaminated base metal	Remove materials like paint, grease, oil, and dirt, including mill scale from base metal
Contaminated MIG wire	Use clean dry rust free wire. Do not lubricate the wire with oil, grease etc
Gas nozzle clogged with spatter, worn or out of shape	Clean or replace the gas nozzle
Missing or damaged gas diffuser	Replace the gas diffuser
MIG torch Euro connect O-ring missing or damaged	Check and replace the O-ring
3: Wire stubbing during welding	
Possible Reason	Suggested Remedy
Holding the torch too far away	Bring the torch closer to the work and maintain stick out of 5-10mm
Welding voltage set too low	Increase the voltage
Wire Speed set too high	Decrease the wire feed speed
4: Lack of Fusion – failure of weld metal to fuse completely with base metal or a proceeding weld bead.	
Possible Reason	Suggested Remedy
Contaminated base metal	Remove materials like paint, grease, oil, and dirt, including mill scale from base metal
Not enough heat input	Select a higher voltage range and /or adjust the wire speed to suit
Improper welding technique	Keep the arc at the leading edge of the weld pool. Gun angle to work should be between 5 & 15° Direct the arc at the weld joint Adjust work angle or widen groove to access bottom during welding Momentarily hold arc on side walls if using weaving technique
5: Excessive Penetration – weld metal melting through base metal	
Possible Reason	Suggested Remedy
Too much heat	Select a lower voltage range and /or adjust the wire speed to suit Increase travel speed
6: Lack of Penetration – shallow fusion between weld metal and base metal	
Poor in incorrect joint preparation	Material too thick. Joint preparation and design needs to allow access to bottom of groove while maintaining proper welding wire extension and arc characteristics Keep the arc at the leading edge of the weld pool and maintain the gun angle at 5 & 15° keeping the stick out between 5-10mm
Not enough heat input	Select a higher voltage range and /or adjust the wire speed to suit Reduce travel speed
Contaminated base metal	Remove materials like paint, grease, oil, and dirt, including mill scale from base metal.

The following chart addresses some of the common WIRE FEED problems during MIG welding. In all cases of equipment malfunction, the manufacturer's recommendations should be strictly adhered to and followed.

1: No wire feed	
Possible Reason	Suggested Remedy
Wrong mode selected	Check that the TIG/MMA/MIG selector switch set to MIG position
Wrong torch selector switch	Check that the STANDARD/SPOOL GUN selector switch is set to STANDARD position for MIG welding and SPOOL GUN when using the spool gun
2: Inconsistent / interrupted wire feed	
Possible Reason	Suggested Remedy
Adjusting wrong dial	Be sure to adjust the WIRE FEED and VOLTAGE dials for MIG welding. The AMPERAGE dial is for STICK and TIG welding mode
Wrong polarity selected	Select the correct polarity for the wire being used - see machine setup guide
Incorrect wire speed setting	Adjust the wire feed speed
Voltage setting incorrect	Adjust the voltage setting
MIG torch lead too long	Small diameter wires and soft wires like aluminium don't feed well through long torch leads - replace the torch with a lesser length torch
MIG torch lead kinked or too sharp angle being held	Remove the kink, reduce the angle or bend
Contact tip worn, wrong size, wrong type	Replace the tip with correct size and type
Liner worn or clogged (the most common causes of bad feeding)	Try to clear the liner by blowing out with compressed air as a temporary cure, it is recommended to replace the liner
Wrong size liner	Install the correct size liner
Blocked or worn inlet guide tube	Clear or replace the inlet guide tube
Wire misaligned in drive roller groove	Locate the wire into the groove of the drive roller
Incorrect drive roller size	Fit the correct size drive roller e.g.; 0.8mm wire requires 0.8mm drive roller
Wrong type of drive roller selected	Fit the correct type roller (e.g. knurled rollers needed for flux cored wires)
Worn drive rollers	Replace the drive rollers
Drive roller pressure too high	Can flatten the wire electrode causing it to lodge in the contact tip - reduce the drive roller pressure
Too much tension on wire spool hub	Reduce the spool hub brake tension
Wire crossed over on the spool or tangled	Remove the spool untangle the wire or replace the wire
Contaminated MIG wire	Use clean dry rust free wire. Do not lubricate the wire with oil, grease etc

The following chart addresses some of the common problems of DC TIG welding. In all cases of equipment malfunction, the manufacturer's recommendations should be strictly adhered to and followed.

1: Tungsten burning away quickly	
Possible Reason	Suggested Remedy
Incorrect Gas or No Gas	Use pure Argon. Check cylinder has gas, connected, turned on and torch valve is open
Inadequate gas flow	Check the gas is connected, check hoses, gas valve and torch are not restricted.
Back cap not fitted correctly	Make sure the torch back cap is fitted so that the O-ring is inside the torch body
Torch connected to DC +	Connect the torch to the DC- output terminal
Incorrect tungsten being used	Check and change the tungsten type if necessary
Tungsten being oxidised after weld is finished	Keep shielding gas flowing 10-15 seconds after arc stoppage. 1 second for each 10 amps of weld current.
2: Contaminated tungsten	
Possible Reason	Suggested Remedy
Touching tungsten into the weld pool	Keep tungsten from contacting weld puddle. Raise the torch so that the tungsten is off of the work piece 2 - 5mm
Touching the filler wire to the tungsten	Keep the filler wire from touching the tungsten during welding, feed the filler wire into the leading edge of the weld pool in front of the tungsten
3: Porosity - poor weld appearance and colour	
Possible Reason	Suggested Remedy
Wrong gas / poor gas flow /gas leaks	Use pure argon. Gas is connected, check hoses, gas valve and torch are not restricted. Set the gas flow between 6-12 l/min. Check hoses and fittings for holes, leaks etc.,
Contaminated base metal	Remove moisture and materials like paint, grease, oil, and dirt from base metal
Contaminated filler wire	Remove all grease, oil, or moisture from filler metal.
Incorrect filler wire	Check the filler wire and change if necessary
4: Yellowish residue / smoke on the alumina nozzle & discoloured tungsten	
Possible Reason	Suggested Remedy
Incorrect Gas	Use pure Argon gas
Inadequate gas flow	Set the gas flow between 10 - 15 l/min flow rate
Alumina gas nozzle too small	Increase the size of the alumina gas nozzle
5: Unstable Arc during DC welding	
Possible Reason	Suggested Remedy
Torch connected to DC +	Connect the torch to the DC- output terminal
Contaminated base metal	Remove materials like paint, grease, oil, and dirt, including mill scale from base metal.
Tungsten is contaminated	Remove 10mm of contaminated tungsten and re grind the tungsten
Arc length too long	Lower torch so that the tungsten is off of the work piece 2 - 5mm
6: Arc wanders during DC welding	
Possible Reason	Suggested Remedy
Poor gas flow	Check and set the gas flow between 10 - 15 l/min flow rate
Incorrect arc length	Lower torch so that the tungsten is off of the work piece 2 - 5mm
Tungsten incorrect or in poor condition	Check that correct type of tungsten is being used. Remove 10mm from the weld end of the tungsten and re sharpen the tungsten
Poorly prepared tungsten	Grind marks should run lengthwise with tungsten, not circular. Use proper grinding method and wheel.
Contaminated base metal or filler wire	Remove contaminating materials like paint, grease, oil, and dirt, including mill scale from base metal. Remove all grease, oil, or moisture from filler metal.
7: Arc difficult to start or will not start DC welding	
Possible Reason	Suggested Remedy
Incorrect machine set up	Check machine set up is correct
No gas, incorrect gas flow	Check the gas is connected and cylinder valve open, check hoses, gas valve and torch are not restricted. Set the gas flow between 10 - 15 l/min flow rate
Incorrect tungsten size or type	Check and change the size and or the tungsten if required
Loose connection	Check all connectors and tighten
Earth clamp not connected to work	Connect the earth clamp directly to the work piece wherever possible

MMA (STICK) WELDING TROUBLE SHOOTING

The following chart addresses some of the common problems of MMA welding. In all cases of equipment malfunction, the manufacturer's recommendations should be strictly adhered to and followed.

1: No arc	
<i>Possible Reason</i>	<i>Suggested Remedy</i>
Incomplete welding circuit	Check earth lead is connected. Check all cable connections.
Wrong mode selected	Check the MMA selector switch is selected
No power supply	Check that the machine is switched on and has a power supply
2: Porosity – small cavities or holes resulting from gas pockets in weld metal.	
<i>Possible Reason</i>	<i>Suggested Remedy</i>
Arc length too long	Shorten the arc length
Work piece dirty, contaminated or moisture	Remove moisture and materials like paint, grease, oil, and dirt, including mill scale from base metal
Damp electrodes	Use only dry electrodes
3: Excessive Spatter	
<i>Possible Reason</i>	<i>Suggested Remedy</i>
Amperage too high	Decrease the amperage or choose a larger electrode
Arc length too long	Shorten the arc length
3: Weld sits on top, lack of fusion	
<i>Possible Reason</i>	<i>Suggested Remedy</i>
Insufficient heat input	Increase the amperage or choose a larger electrode
Work piece dirty, contaminated or moisture	Remove moisture and materials like paint, grease, oil, and dirt, including mill scale from base metal
Poor welding technique	Use the correct welding technique or seek assistance for the correct technique
4: Lack of penetration	
<i>Possible Reason</i>	<i>Suggested Remedy</i>
Insufficient heat input	Increase the amperage or choose a larger electrode
Poor welding technique	Use the correct welding technique or seek assistance for the correct technique
Poor joint preparation	Check the joint design and fit up, make sure the material is not too thick. Seek assistance for the correct joint design and fit up
5: Excessive penetration - burn through	
<i>Possible Reason</i>	<i>Suggested Remedy</i>
Excessive heat input	Reduce the amperage or use a smaller electrode
Incorrect travel speed	Try increasing the weld travel speed
6: Uneven weld appearance	
<i>Possible Reason</i>	<i>Suggested Remedy</i>
Unsteady hand, wavering hand	Use two hands where possible to steady up, practise your technique
7: Distortion – movement of base metal during welding	
<i>Possible Reason</i>	<i>Suggested Remedy</i>
Excessive heat input	Reduce the amperage or use a smaller electrode
Poor welding technique	Use the correct welding technique or seek assistance for the correct technique
Poor joint preparation and or joint design	Check the joint design and fit up, make sure the material is not too thick. Seek assistance for the correct joint design and fit up
7: Electrode welds with different or unusual arc characteristic	
<i>Possible Reason</i>	<i>Suggested Remedy</i>
Incorrect polarity	Change the polarity, check the electrode manufacturer for correct polarity

SPARE PARTS IDENTIFICATION

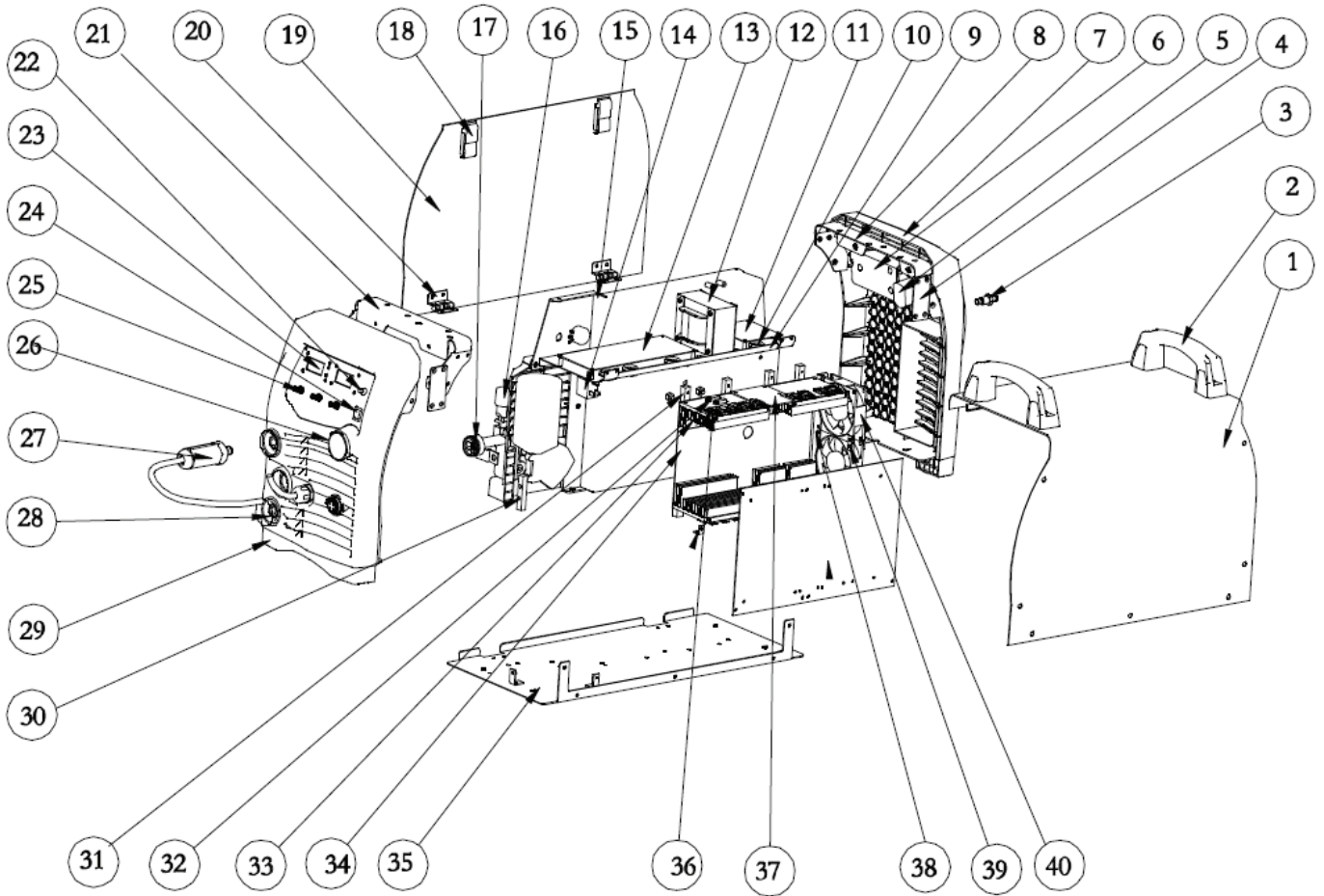

#	Part Number	Description	#	Part Number	Description
1	10052910	cover	22	10052570	potentiometer
2	10052969	handle	23	10046712	display meter
3	10045120	joint gas inlet	24	10062440	rocker switch
4	10052556	clap board bracket	25	30000103	knob
5	10052689	air switch	26	10052964	brand cover
6	10052698	insulation cover	27	10052585	plug
7	10052970	rear panel	28	10004638	quick socket
8	10052566	back panel bracket	29	10052971	front panel
9	10052604	top clap board	30	10052663	column
10	10022104	protective ring	31	10052595	long column
11	10052534	EMC board	32	10052602	thermoswitch
12	10052621	transformer	33	10052565	rectifying heat sink
13	10052552	control board	34	10052681	insulation paper
14	10052546	solenoid valve	35	10052560	machine base
15	10052532	middle clapboard	36	10043957	diode
16	10052536	wire feeder	37	10052596	insulation board
17	10052636	central socket	38	10052564	fan bracket
18	10016524	door holder	39	10052662	insulation board
19	10052909	cover	40	10044009	DC fan
20	10052708	loose sheet	41	10061177	spool holder
21	10052563	front panel bracket	42	10052697	fixed shield

WARRANTY TERMS

UNIMIG

BUILT FOR WELDERS

Welding Guns Of Australia Pty Ltd ('Us', 'We') warrants that the following products under UNIMIG, UNI-TIG, UNI-PLAS, UNI-FLAME, TECNA, T&R, HIT-8SS & ROTA, supplied by Us and purchased by you from an Authorised UNIMIG, UNI-TIG, UNI-PLAS, UNI-FLAME, TECNA, T&R, HIT-8SS & ROTA Dealer throughout Australia are free of Material and Faulty Workmanship defects except for those products listed under 'Warranty Exclusions'.

These terms and conditions supersede and exclude all former and other representations and arrangements relating to any warranties on these products.

WARRANTY PERIOD

We offer the following 'Warranty Periods' from 'date of purchase':

An Extended Warranty Period of 6 months total shall apply only to Machinery where offered and warranty is registered online.

UNIMIG WELDING MACHINES

UNIMIG DIY Series (Power Source Only)	2 Years	(Clause 3)
UNIMIG Procraft Series (Power Source Only)	3 Years	(Clause 1&3)
UNIMIG Trade Series (Power Source Only)	3 Years	(Clause 1&3)
UNIMIG Trade Series SWF (Power Source / Separate Wire Feeder Only)	3 Years	(Clause 1&3)
UNIMIG Workshop Series (Power Source Only)	3 Years	(Clause 1&3)
UNIMIG Workshop Series SWF (Power Source / Separate Wire Feeder Only)	3 Years	(Clause 1&3)
UNIMIG Jasic Inverter MIG (Power Source Only)	3 Years	(Clause 3)
UNIMIG Jasic Inverter MIG SWF (Power Source / Separate Wire Feeder Only)	3 Years	(Clause 3)
UNI-TIG Jasic Inverter TIG (Power Source Only)	3 Years	(Clause 3)
UNIMIG Water Cooler	1 Year	(Clause 3)
T&R Pulse MIG (Power Source Only)	2 Year	(Clause 3)
T&R Pulse MIG SWF (Power Source / Separate Wire Feeder Only)	2 Year	(Clause 3)
UNI-PLAS (Power Source Only)	3 Years	(Clause 3)
UNI-PLAS Jasic Series (Power Source Only)	2 Years	(Clause 3)
UNI-PLAS Site Cut Series (Power Source Only)	1 Year	(Clause 3)
UNI-FLAME Gas Cutting and Welding Kits	3 Months	(Clause 2&3)
UNI-FLAME Straight Line & Gas Cutting Machines (Power Source Only)	1 Year	(Clause 3)
UNI-FLAME Regulators Argon/ Acetylene / Oxygen / LPG / Bobbin Flowmeter	1 Year	
UNI-FLAME Automatic Welding Helmet	2 Years	
UNIMIG Automatic Welding Helmets	2 Years	
TECNA (Power Source Only)	1 Year	(Clause 3)
HIT-8SS Automatic Carriage (Power Source Only)	1 Year	(Clause 3)
ROTA 102 Rotating table	1 Year	
HOTBOX Electrode Oven	1 Year	
SPOTCAR 3500	1 Year	(Clause 3)
TORCHES -GMAW, GTAW, MMAW, PLASMA, EARTH LEADS, INTERCONNECTING CABLES, GAS HOSE	3 Months	(Clause 3)
UNIMIG VIPER RANGE	1 Year	
UNIMIG VIPER MIG 185 / VIPER TIG 180 AC/DC	2 Years	

(Clause 1) 3 year warranty on transformers, inductor and rectifier. 1 year warranty on PCB, and all other components, .

(Clause 2) Gas Hose, Flashbacks are subject to and covered by the Manufacturer's Individual Warranty, Contact the manufacturer for details

(Clause 3) This only Covers Manufactures defaults on all accessories for the first three months after date of purchase.

WARRANTY / RETURNS / EXCHANGES

We understand that sometimes you may need to return a product you have purchased from Welding Guns Of Australia PTY LTD Authorised Dealer Network, to assist you, we have set out below the Welding Guns Of Australia PTY LTD Returns Policy that you should know.

Our Returns Policy includes the rights you have under the Australian Consumer Law and other relevant laws.

Your Rights under the Australian Consumer Law - Our goods come with guarantees that cannot be excluded under the Australian Consumer Law. You are entitled to a replacement or refund for a major failure and for compensation for any other reasonably foreseeable loss or damage. You are also entitled to have the goods repaired or replaced if the goods fail to be of acceptable quality and the failure does not amount to a major failure.

- You shall inspect the Goods on delivery and shall within seven (7) days of delivery (time being of the essence) notify Welding Guns Of Australia PTY LTD of any alleged defect, shortage in quantity, damage or failure to comply with the description or quote.
- You shall also afford Welding Guns Of Australia PTY LTD the opportunity to inspect the Goods within a reasonable time following delivery if you believe the Goods are defective in any way.
- If you shall fail to comply with these provisions the Goods shall be presumed to be free from any defect or damage. For defective Goods, which Welding Guns Of Australia PTY LTD has agreed in writing that you are entitled to reject, Welding Guns Of Australia PTY LTD liability is limited to either (at the Welding Guns Of Australia PTY LTD discretion) replacing the Goods or repairing the Goods except where you have acquired Goods as a consumer within the meaning of the Trade Practices Act 1974 or the Fair Trading Acts of the relevant state or territories of Australia, and is therefore also entitled to, at the consumer's discretion either a refund of the purchase price of the Goods, or repair of the Goods, or replacement of the Goods.

Returns will only be accepted provided that:

- a. You have complied with the provisions outlined above, and
 - b. Where the Goods are unable to be repaired, the Goods are returned at your cost within thirty (30) days of the delivery date, and
 - c. Welding Guns Of Australia PTY LTD will not be liable for Goods which have not been stored or used in a proper manner, and
 - d. The Goods are returned in the condition in which they were delivered and with all packaging material, brochures and instruction material in as new condition as is reasonably possible in the circumstances.
- Welding Guns Of Australia PTY LTD Accepts no responsibility for products lost, damaged or mislaid whilst in transit
 - Welding Guns Of Australia PTY LTD may (at their sole discretion) accept the return of Goods for credit but this may incur a handling fee of up to fifteen percent (15%) of the value of the returned Goods plus any freight costs.
 - Where a failure does not amount to a major failure, Welding Guns Of Australia PTY LTD is entitled to choose between providing you with a repair, replacement or other suitable remedy.
 - Your rights under the Australian Consumer Law are not limited by a defined time. However, the Australian Consumer Law does recognise that the relevant time period can vary from product to product, depending on factors such as the nature of the product and the price. Welding Guns Of Australia PTY LTD adopts the same approach. As you can appreciate, the type of remedy we can offer you may also vary depending on how long it takes you to return the product to us.

MAKING A CLAIM

If you wish to make a claim under this Warranty, you should:

- Return the product to the point of purchase either in person or on a prepaid courier; or
- Contact Us by Telephone on 02 9870 4200 or Mail PO Box 3033 Lansvale NSW 2166.

When returned, the product must be accompanied with the original invoice including the purchase price and disclosing the purchase date

All costs of installation, cartage, freight, travelling expenses, hiring tools and insurance are paid by the Customer.

To the extent permitted by law, our total liability for loss or damage of every kind related to the product in any way whatsoever is limited to the amount paid to the retailer by you for the product or the value of the product.

No responsibility will be taken for products lost, damaged or mislaid whilst in transit.

WARRANTY EXCLUSIONS

This Warranty covers Material and Faulty Workmanship defects only.

This Warranty does not cover damage caused by:

- Normal wear and tear due to usage
- Misuse or abusive use of the UNIMIG, UNI-TIG, UNI-PLAS, UNI-FLAME, TECNA, T&R, HIT-8SS & ROTA, instructions supplied with the product.
- Failure to clean or improper cleaning of the product
- Failure to maintain the equipment such as regular services etc
- Incorrect voltage or non-authorised electrical connections
- Improper installation
- Use of non-authorised/non-standard parts
- Abnormal product performance caused by any ancillary equipment interference or other external factors
- Failure or any breakage caused by overload, dropping or abusive treatment or use by the customer
- Repair, modifications or other work carried out on the product other than by an Authorised UNIMIG, UNI-TIG, UNI-PLAS, UNI-FLAME, TECNA, T&R, HIT-8SS & ROTA Service Dealer

Unless it is a manufacturing fault, this Warranty does not cover the following parts:

MIG Welding Torches and Consumables to suit, such as:

Gas Nozzles, Gas Diffusers, Contact Tip holder, Contact tip, Swan Necks, Trigger, Handle, Liners, Wire Guide, Drive Roller, Gas Nozzle Spring, Neck Spring, Connector Block, Insulator, Gas Nipple, Cap, Euro Block, Head Assembly, Gas Block, Trigger Spring, Spring Cable Support, Neck Insulator, Shroud Spring, Gun Plug Cover, Lock Nut, Snap On Head, Spring Cap, Ball, Motor 42 Volt, Pot 10K standard, Knob, Drive Roll Seat, Washer, Bow, Ball Bearing, Wire Condu Nipple, Central Plug, Printed Circuit Board, Gun Plug House, Cable Support, Gas Connector, Handle To Suit PP36 with Knobs, All Xcel-Arc/ Magmaweld MIG Welding Wires & Electrodes, Arc Leads, Welding Cable, Electrode Holder, Earth Clamps

TIG Welding Torches and Consumables to suit, such as:

Tungsten Electrodes, Collet, Collet Body, Alumina Nozzle, Torch Head, Torch Head water Cooled, Torch Head Flexible, Back Caps, Gas Lens, Torch Handle, Cup Gasket, Torch Body Gas Valve, O-ring, All UNIMIG TIG Welding Rods, All Xcel-Arc/ Magmaweld Electrodes, Arc Leads, Welding Cable, Electrode Holder, Earth Clamps.

PLASMA Cutting Torches and Consumables to suit, such as:

All Cutting Tips, All Diffuser/Swirl Ring, All Electrode, Retaining Caps, Nozzle Springs, All Spacers, All Shield Caps, All Air and Power Cables, All Switches, All O-rings, All Springs, All Circle Guides and Cutting Kits, Torch Bodies, Air Filter Regulator, Arc Leads, Welding Cable, Electrode Holder, Earth Clamps

STRAIGHT LINE CUTTING MACHINES and Consumables to suit, such as:

Hoses, Fittings, Track, Cutting Nozzles.

HIT-8SS Welding Carriage Consumables to suit, such as:

Input Cord, Inter-connecting Cord, Triggering Cable.

This Warranty does not cover products purchased:

- From a non-authorised UNIMIG, UNI-TIG, UNI-PLAS, UNI-FLAME, TECNA, T&R, HIT-8SS & ROTA Dealer (such as purchases from unauthorised retailers and purchases over the Internet from unauthorised local/international sellers or sites such as EBay)
- At an auction;
- From a private seller

Unless it is a manufacturing fault, this Warranty does not apply to any products sold to Hire Companies.

These conditions may only be varied with the written approval of the Directors of Welding Guns Of Australia PTY LTD

REMEMBER TO RETAIN YOUR ORIGINAL INVOICE FOR PROOF OF PURCHASE.

UNIMIG

*Razor*Weld

UNIMIG

Welding Guns Of Australia Pty Ltd

ABN: 14 001 804 422

PO Box 3033, Lansvale NSW 2166, AUSTRALIA

112 Christina Rd, Villawood, NSW 2163

Phone: 1300 864 644

Fax: (02) 9780 4244

Email: sales@unimig.com.au

www.unimig.com.au